

TRACER 2 & TRACER 2SS

Installation and Operating Manual For
Industrial Building Automation Controller
Software Revision 1.12 (& Higher)
Hardware revision A & B

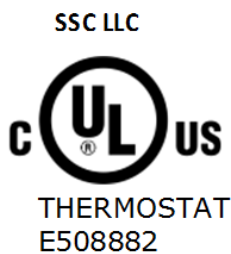

UL 60730-1 AUTOMATIC ELECTRICAL CONTROLS - PART 1: GENERAL REQUIREMENTS- Edition 5 - Issue Date 2016/08/03
CSA E60730-1 AUTOMATIC ELECTRICAL CONTROLS - PART 1: GENERAL REQUIREMENTS- Edition 5 - Issue Date 2015/12/01
CSA E60730-2-9 AUTOMATIC ELECTRICAL CONTROLS FOR HOUSEHOLD AND SIMILAR USE - PART 2-9: PARTICULAR REQUIREMENTS FOR TEMPERATURE SENSING CONTROLS- Edition 3 - Issue Date 2015/09/01
UL 60730-2-9 STANDARD FOR AUTOMATIC ELECTRICAL CONTROLS - PART 2-9: PARTICULAR REQUIREMENTS FOR TEMPERATURE SENSING CONTROLS- Edition 4 - Issue Date 2017/02/14

This standard is applicable to automatic electrical temperature sensing controls forming part of a building automation control system within the scope of ISO 16484. This standard also applies to automatic electrical temperature sensing controls for equipment that may be used by the public, such as equipment intended to be used in shops, offices, hospitals, and commercial and industrial applications. This component complies with UL requirements.

Controller Part Number Series: 7300-13001-XX
Document Part Number: 7200-00001-00
Document Revision: Jan 22, 2023

Contents



1. Safety Precautions	3
2. Product Overview	5
3. Models and Part Numbers:	6
4. Controller Operation	7
5. Pre-Check	9
6. TRACER 2 Installation Requirements	10
7. TRACER 2SS Installation Requirements.....	13
8. Operation	16
a. Power Board.....	16
b. Controller Board.....	16
9. Navigation	17
10. Programming	18
11. Parameter Summary and Default Settings	27
12. Security Levels.....	28
13. Alarms and Error Handling.....	29
14. Sensor Settings Probe Hierarchy.....	32
15. Auto Cycle	33
16. Circuit Configuration For 1 or 2 Circuit Display.....	33
17. DIGITAL I/O Operation	34
18. Lock Out Operation	34
19. Special 2 Circuit Configuration for 7300-13001- 81	35
20. Mechanical Drawing	35
21. Technical Specifications	36
22. Torque Specifications.....	37
23. Panel & Display Board Layout	37
24. Power Board Layout and Wiring Diagrams	38
25. Digital I/O Wiring Diagram	42
26. Modbus	43
27. BacNet.....	50
28. Ethernet	50
29. Service Information.....	50
30. Boot loading New Firmware into TRACER2	50
31. Factory Service Menus.....	51
32. UL Model Number Description	52
33. Internal Labeling Requirements.....	53
34. Troubleshooting.....	54
35. Contact Information.....	54
36. Revision Record.....	55



1. Safety Precautions

Your safety and the safety of others are very important.

This Section of the Manual was developed for general education purposes only and is not intended to replace an electrical safety-training program or to serve as a sole source of reference. The information herein is also not intended to serve as recommendations or advice for specific situations. It is the responsibility of the user to comply with all applicable safety standards, including the requirements of the U.S. Occupational Safety and Health Administration (OSHA), the National Fire Protection Association (NFPA), and other appropriate governmental and industry accepted guidelines, codes, and standards.

We have provided many important safety messages in this manual and on your appliance. Always read and obey all safety messages.

	<p>This is the safety alert symbol. This symbol alerts you to potential hazards that can kill or hurt you and others. All safety messages will follow the safety alert symbol and either the word “DANGER” or “WARNING.” These words mean:</p> <p>C'est le symbole d'alerte de sécurité. Ce symbole vous avertit des dangers potentiels pouvant vous tuer ou vous blesser, ainsi que d'autres personnes. Tous les messages de sécurité suivront le symbole d'alerte de sécurité et le mot «DANGER» ou «AVERTISSEMENT». Ces mots signifient:</p>
 DANGER	<p>You can be killed or seriously injured if you don't immediately follow instructions.</p> <p>Vous pouvez être tué ou gravement blessé si vous ne suivez pas immédiatement les instructions.</p>
 WARNING	<p>You can be killed or seriously injured if you don't follow instructions.</p> <p>Vous pouvez être tué ou gravement blessé si vous ne suivez pas les instructions.</p>

 WARNING	<p>The system designer is responsible for the safety of this equipment and should install adequate back-up controls and safety devices with their electric heating equipment. Where the consequences of failure could result in personal injury or property damage, back-up controls are essential.</p> <p>Le concepteur du système est responsable de la sécurité de cet équipement et doit installer des commandes de secours et des dispositifs de sécurité adéquats avec leur équipement de chauffage électrique. Lorsque les conséquences d'une défaillance peuvent entraîner des blessures corporelles ou des dommages matériels, des contrôles de secours sont indispensables.</p>
 DANGER	<p>ELECTRIC SHOCK HAZARD. Disconnect all power before installing or servicing heater. Failure to do so could result in personal injury or property damage. Heater must be installed by a qualified person in accordance with the National Electrical Code, NFPA 70.</p> <p>RISQUE D'ÉLECTROCUTION. Débranchez toutes les sources d'alimentation avant d'installer ou de réparer le chauffage. Ne pas le faire pourrait entraîner des blessures ou des dommages matériels. Le chauffage doit être installé par une personne qualifiée conformément au code national de l'électricité, NFPA 70.</p>

2. Product Overview

The **TRACER 2** is a state-of-the-art controller designed for contact, line sensing or ambient sensing to control freeze protection heating cables and other process applications. The **TRACER 2SS** is the same state of the art controller with a stainless-steel enclosure.

The controller is programmable to meet the specific needs of various applications. It also provides supervisor data including operating statistics and prognostics through a password protected menu option.

The controller provides inrush software protection for resistive loads. It provides sensor management functions to ensure proper operation if a sensor should fail. Alarms and alarm outputs are software configurable and the controller output may be operated in an open loop, closed loop or manual mode to ensure maximum protection.

The **TRACER 2** is enclosed in an IP66, NEMA 4X FG enclosure measuring 10" x 8" x 6". It is sold complete with 2 mounting brackets.

The **TRACER 2SS** is enclosed in an IP66, NEMA 4X SS enclosure measuring 12" x 10" x 6". It is sold complete with 2 mounting brackets.

The **TRACER 2 & TRACER 2SS** Digital Heat Trace Controller is a state-of-the-art unit with many features such as:

- cUL approved for safe and reliable operation
- One or two loop controllers.
- Universal AC Input Power Supply with 50/60Hz operation
- Operating Range –35°F to 104°F
- 2 /4 wire RS485 (Modbus) and optional Ethernet communications ports
- Domed membrane sealed keypad for reliable operation
- Real Time Clock Calendar with battery backup
- USB port
- Ethernet Port Options
- Two Sensors per loop interfaced to a 3-wire high precision processor
- Programmable Ground Fault monitoring with multiple alarm options
- SSR outputs rated at 30 amps per loop
- Ground Fault Equipment Protection
- Sensor monitoring and Failure detection
- AC Alarm, DC Alarm and optional mechanical dry contact alarms
- Super bright 3.5" 320 x 240-pixel color display
- Fully isolated power management features for real time management and data recording with prognostics.
- "Ambient" mode allows for differential process and alarms monitoring using two independent sensors. Circuit 2 may be configured to use circuit 1 or circuit 2 sensors for set point and alarms.
- "Lock-Out" mode utilizes a remote switch contact that can turn the controller off or on independent of process temperature.
- "Digital I/O" mode allows the use of a remote dry contact switch to control the output of the controller.

3. Models and Part Numbers:

Part Number	Model Number	Configuration							
		# CKTS	RS485 MODBUS	CIRCUIT 1		CIRCUIT 2		OVERLAY	OPTIONS
				DC ALARM	AC ALARM	DC ALARM	AC ALARM		
7300-13001-01(*)	T2-2019-1-00-2200-00-00	1	YES	DC SSR	DC SSR	NONE	NONE	STANDARD	NONE
7300-13001-02(*)	T2-2019-2-00-2222-00-00	2	YES	DC SSR	DC SSR	DC SSR	DC SSR	STANDARD	NONE
7300-13001-03(*)	T2-2019-1-00-1100-00-00	1	YES	MECH RLY.	MECH RLY.	NONE	NONE	STANDARD	NONE
7300-13001-04(*)	T2-2019-2-00-1111-00-00	2	YES	MECH RLY.	MECH RLY.	MECH RLY.	MECH RLY.	STANDARD	NONE
7300-13001-07(*)	T2-2019-1-00-1100-00-00	1	YES	MECH RLY.	MECH RLY.	NONE	NONE	STANDARD	OPTION KIT P/N 6400-00001-00
7300-13001-08(*)	T2-2019-2-00-1111-00-00	2	YES	MECH RLY.	MECH RLY.	MECH RLY.	MECH RLY.	STANDARD	OPTION KIT P/N 6400-00001-00
7300-13001-07(*)SS	T2-2022-1-00-1100-00-00	1	YES	MECH RLY.	MECH RLY.	NONE	NONE	STANDARD	Stainless Steel 304 Enclosure And option kit P/N 6400-00001-00
7300-13001-08(*)SS	T2-2022-2-00-1111-00-00	2	YES	MECH RLY.	MECH RLY.	MECH RLY.	MECH RLY.	STANDARD	Stainless Steel 304 Enclosure And option kit P/N 6400-00001-00
7300-13001-07(*)SS6	T2-2022-1-00-1100-00-00	1	YES	MECH RLY.	MECH RLY.	NONE	NONE	STANDARD	Stainless Steel 316 Enclosure And option kit P/N 6400-00001-00
7300-13001-08(*)SS6	T2-2022-2-00-1111-00-00	2	YES	MECH RLY.	MECH RLY.	MECH RLY.	MECH RLY.	STANDARD	Stainless Steel 316 Enclosure And option kit P/N 6400-00001-00

(*) Part Number may include “R” as a suffix.

4. Controller Operation

The **TRACER 2** is a state-of-the-art controller with many safety and configuration features. These features are configured and managed through the operator interface. The operator interface is an intuitive interface that is easily configurable using the human interface. The human interface consists of six domed tactile membrane keys switches and a 3.5" graphical display. The interface is password protected with 3 levels and a 4th proprietary factory service level. The passwords are user configurable and there is one master password that cannot be changed or reconfigured. Once the **TRACER 2** is installed and configured, the device will operate automatically and will provide energy management, fault protection, and prognostic information.

Interface is as follows:

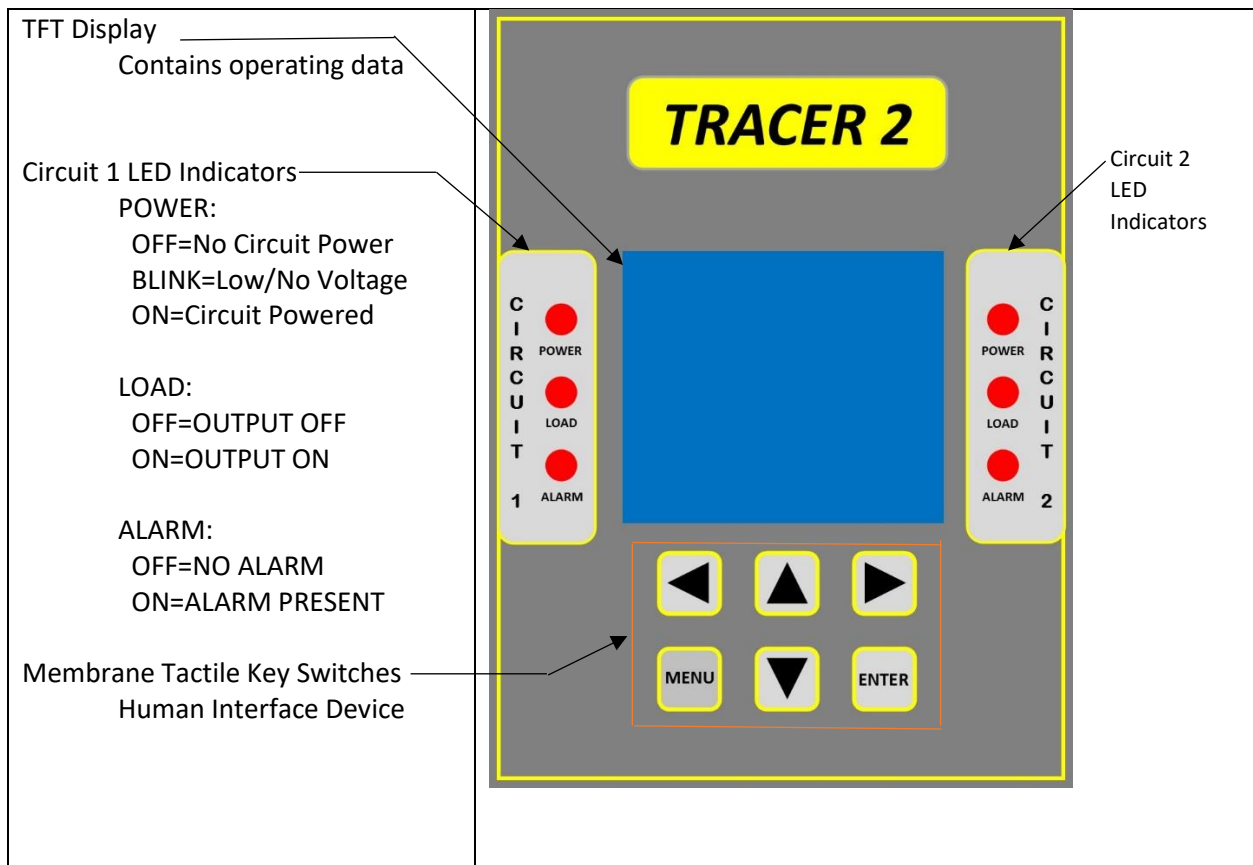

This manual contains information for both one circuit and two circuit units. When using this manual to operate a one circuit unit, please disregard references to "Circuit 2".

During normal operation, the **TRACER 2** will allow navigation through the following screens:

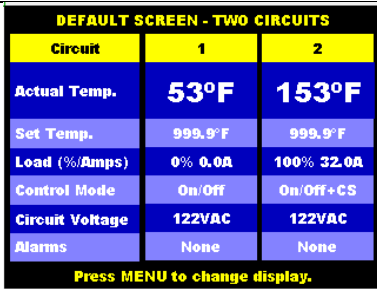
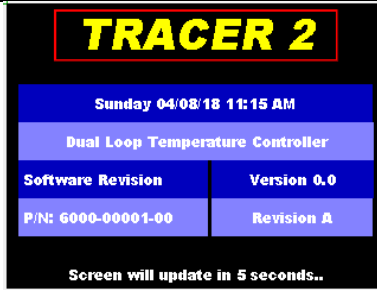
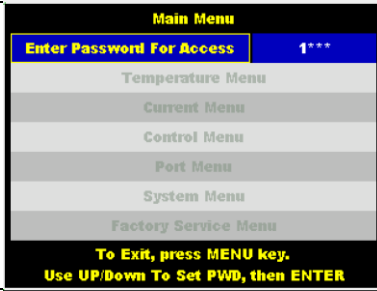
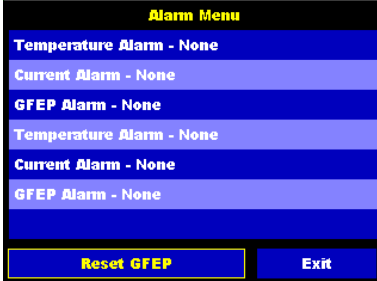
<p><u>Default Screen</u> Provides circuit number. Two circuit screen shown, one circuit controller will show 1 circuit. Also shows process temperature, set temperature, load in amps and as a percentage, control mode, actual circuit voltage in volts or “Pass” depending on model, output status, and alarm status.</p>	
<p><u>Revision Screen</u> Displays real time clock calendar, name of controller, software revision, controller part number and part number revision.</p>	
<p><u>Main Menu</u> Displays password or current level of access when password is entered, and all available parameter menus. Greyed keys are not accessible, while blue keys are accessible based on password level of security.</p>	
<p><u>Alarm Menu</u> Displays current status of alarm conditions. Also, the Reset GFEP button is used to clear a latched GFEP fault.</p>	

For further detail of these screens, programming and operation, please refer to subsequent sections of this operating manual.

5. Pre-Check

In the box, you should have the following items:

- Operating Manual
- TRACER 2 control box
- One set of mounting brackets with mounting hardware

Before proceeding, please verify the items, and verify that the proper unit has been purchased and received. Make certain that the correct number of circuits have been ordered and shipped before proceeding. Open the **TRACER 2** box by loosening the two screws that secure the front panel. Make certain that the proper amount of power boards are mounted inside the box. A one circuit **TRACER 2** will have one power board and a two circuit **TRACER 2** will have two power boards.

Once the installation has begun, the TRACER 2 is not returnable other than for items covered under warranty which include defects in material and workmanship.

Once these items have been verified continue with installation. Remember to inspect the **TRACER 2** installation as follows:

These precautions must be adhered to when the product is installed as well as before every season or on an annual basis, whichever is shortest.

All service must be performed by experienced professionals.

Check wiring and connections as follows:

- a) Inspect wiring for wear, fraying, chipping, nicks, and evidence of overheating. Repair minor defects with a good grade of electrical tape or replace if needed.
- b) Inspect for loose electrical and mechanical connections. Tighten or replace defective crimp-style lugs. Re-solder loose solder connections. Tighten or replace all loose or missing hardware.

6. TRACER 2 Installation Requirements

The TRACER 2 must be mounted in a vertical orientation to provide for convection cooling of the Solid-State Relay device(s). It is recommended that the supplied brackets are used for mounting to provide for mechanical stability and proper clearances for heat sink operation.

The heat sink must be kept free of debris and should be inspected every season and cleaned as required using a high-pressure air flow of clean dry air.

Also, there must be no air restriction above or below the heat sink to allow for proper convection cooling.

Please reference Illustration 1 for mounting. Requirements as follows:

Note 1: Mounting of Brackets to box shall be accomplished using the (4) ¼-10 x .5” screws.

Align the brackets to the (4) mounting holes located in the rear of the TRACER 2 and tighten to a setting of 28-34 inch-pounds.

Note 2: Mounting of TRACER 2 to Surface

It is recommended that the TRACER 2 be mounted using screws with corrosion resistant properties. The surface should be rigid made of concrete metal or wood. Wood surfaces shall be minimum ½” thick wood supported by a minimum size 2” x 4” studding. Mounting anchors should be 300 series stainless steel and a #8 or #10 bolt or screw.

WARNING

All mounting must be performed by experienced professionals.

Tout montage doit être effectué par des professionnels expérimentés.

WARNING

Proper installation of AC power, Alarms, and Temperature Sensors must be installed by an experienced professional. At a minimum, all wires for AC, PRTD and all other wiring that leaves enclosure must be inaccessible by users.

Une installation adéquate de l'alimentation secteur, des alarmes et des capteurs de température doit être installée par un professionnel expérimenté. Au minimum, tous les fils pour AC, PRTD et tous les autres câbles sortant du boîtier doivent être inaccessibles par les utilisateurs.

Illustration 1

⚠ WARNING

The heat sink on the back of the **TRACER 2** provides cooling for the Solid-State Relay Device(s). Care must be taken to ensure that proper clearances are provided for proper and safe operation of the **TRACER 2**. Failure to maintain these clearances could result in damage to the **TRACER 2**, personal injury or both.

Le dissipateur thermique situé à l'arrière du **TRACER 2** assure le refroidissement des dispositifs à relais à semi-conducteurs. Vous devez veiller à ce que des dégagements appropriés soient fournis pour un fonctionnement correct et en toute sécurité du **TRACER 2**. Le non-respect de ces dégagements pourrait entraîner des dommages au **TRACER 2**, des blessures corporelles ou les deux.

TOP VIEW OF TRACER 2 MOUNTING

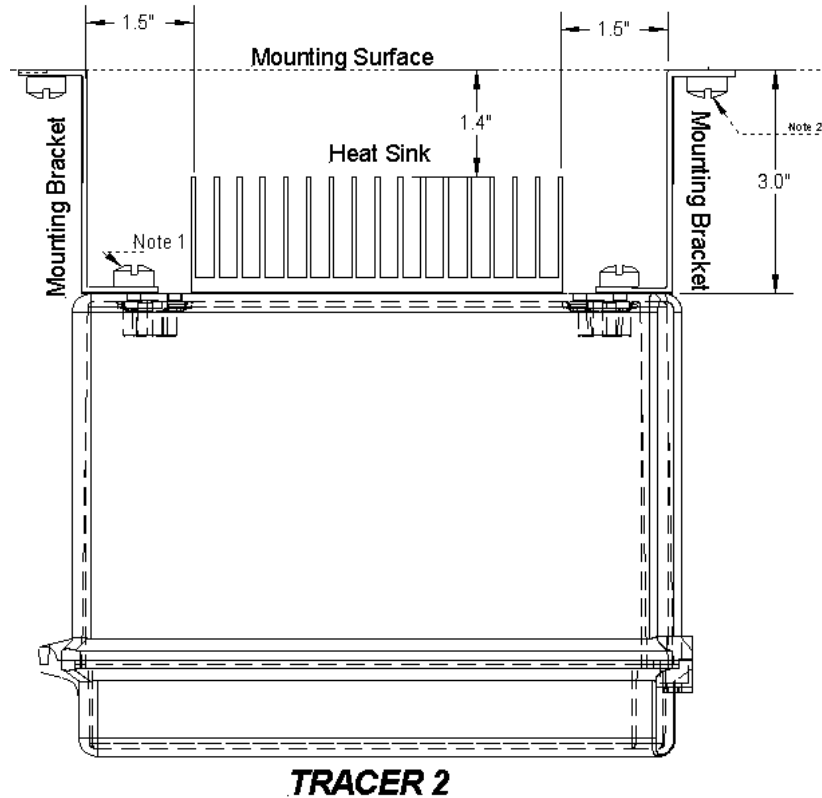

Bracket Dimensions For Wall Mount – Reference Only

WARNING

Improper mounting may cause an unsafe condition resulting in equipment damage or failure which could cause personal injury.

Un montage incorrect peut provoquer une condition dangereuse entraînant des dommages matériels ou une défaillance pouvant causer des blessures.

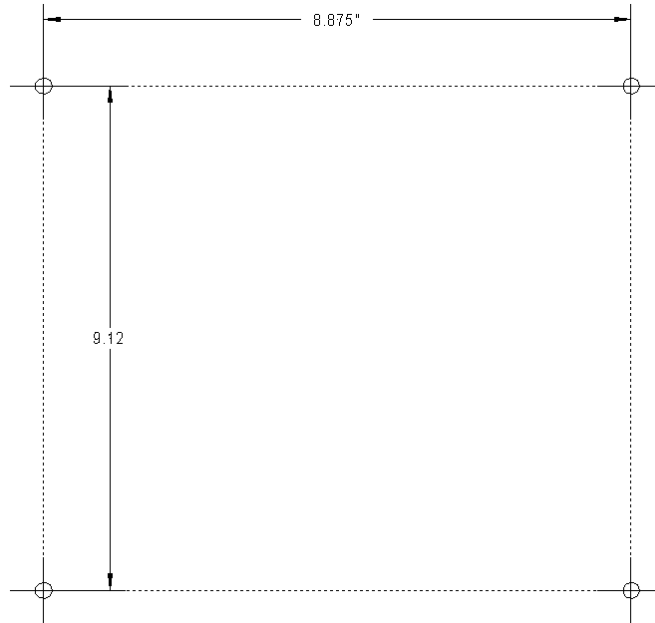

Bracket Orientation:

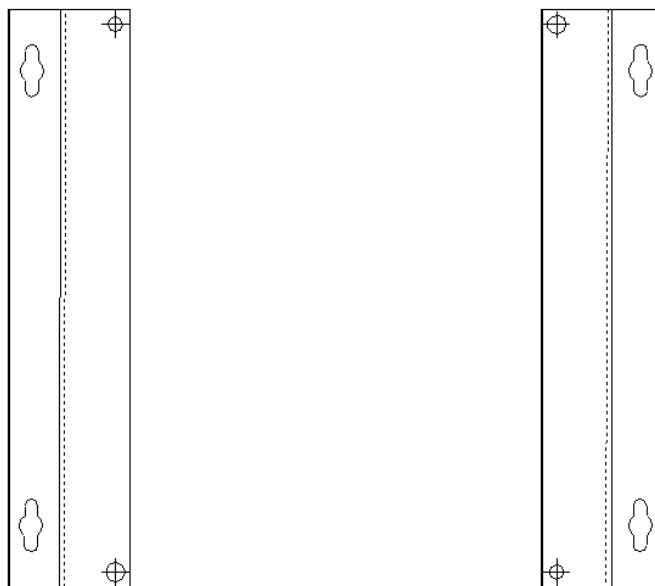

7. TRACER 2SS Installation Requirements

The TRACER 2SS must be mounted in a vertical orientation to provide for convection cooling of the Solid-State Relay device(s). It is recommended that the supplied brackets are used for mounting to provide for mechanical stability and proper clearances for heat sink operation.

The heat sink must be kept free of debris and should be inspected every season and cleaned as required using a high-pressure air flow of clean dry air.

Also, there must be no air restriction above or below the heat sink to allow for proper convection cooling.

Please reference Illustration 1A and 1B for mounting. Requirements as follows:

Note 1: Mounting of Brackets to box shall be accomplished using the supplied (4) M6 screws, washers and nuts. Install the brackets as shown in Illustration 1B. Align the brackets to the (4) mounting holes located in the rear of the TRACER 2 and tighten to a setting of 27-33 inch-pounds.

Note 2: Mounting of TRACER 2 to Surface

It is recommended that the TRACER 2 be mounted using screws with corrosion resistant properties. The surface should be rigid made of concrete metal or wood. Wood surfaces shall be minimum ½" thick wood supported by a minimum size 2" x 4" studding. Mounting anchors should be 300 series stainless steel and a #8 or #10 bolt or screw. Refer to attached illustrations for dimensions and orientation.

WARNING

All mounting must be performed by experienced professionals.

Tout montage doit être effectué par des professionnels expérimentés.

WARNING

Proper installation of AC power, Alarms, and Temperature Sensors must be installed by an experienced professional. At a minimum, all wires for AC, PRTD and all other wiring that leaves enclosure must be inaccessible by users.

Une installation adéquate de l'alimentation secteur, des alarmes et des capteurs de température doit être installée par un professionnel expérimenté. Au minimum, tous les fils pour AC, PRTD et tous les autres câbles sortant du boîtier doivent être inaccessibles par les utilisateurs.

Illustration 1A & 1B

⚠ WARNING

The heat sink on the back of the **TRACER 2SS** provides cooling for the Solid-State Relay Device(s). Care must be taken to ensure that proper clearances are provided for proper and safe operation of the **TRACER 2SS**. Failure to maintain these clearances could result in damage to the **TRACER 2SS**, personal injury or both.

Le dissipateur thermique situé à l'arrière du **TRACER 2SS** assure le refroidissement des dispositifs à relais à semi-conducteurs. Vous devez veiller à ce que des dégagements appropriés soient fournis pour un fonctionnement correct et en toute sécurité du **TRACER 2SS**. Le non-respect de ces dégagements pourrait entraîner des dommages au **TRACER 2SS**, des blessures corporelles ou les deux.

Mounting Instructions:

Mounting holes have been provided in the rear of the enclosure for mounting the included brackets. To ensure proper sealing and enclosure protection rating, use the provided sealing washers. Install sealing washers inside the enclosure with the rubber face against the enclosure. Install as shown below and tighten to 27-33 in-lbs.

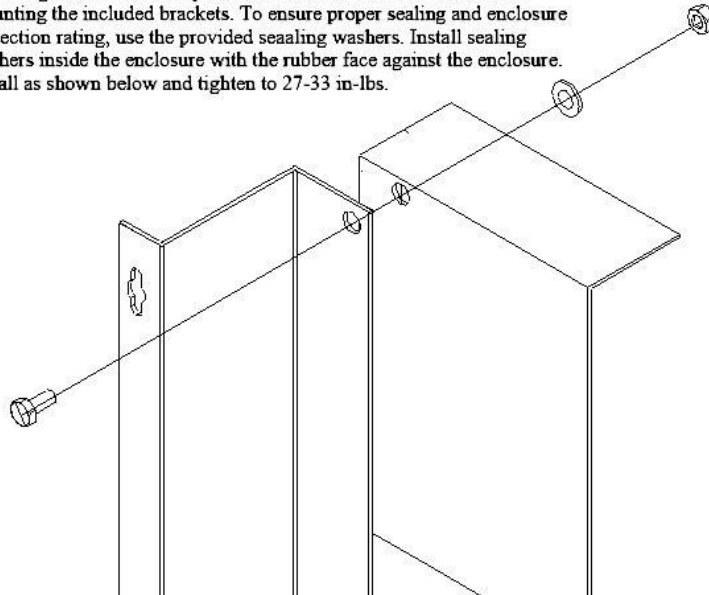

TRACER 2SS BRACKET MOUNTING

TOP VIEW OF TRACER 2SS MOUNTING

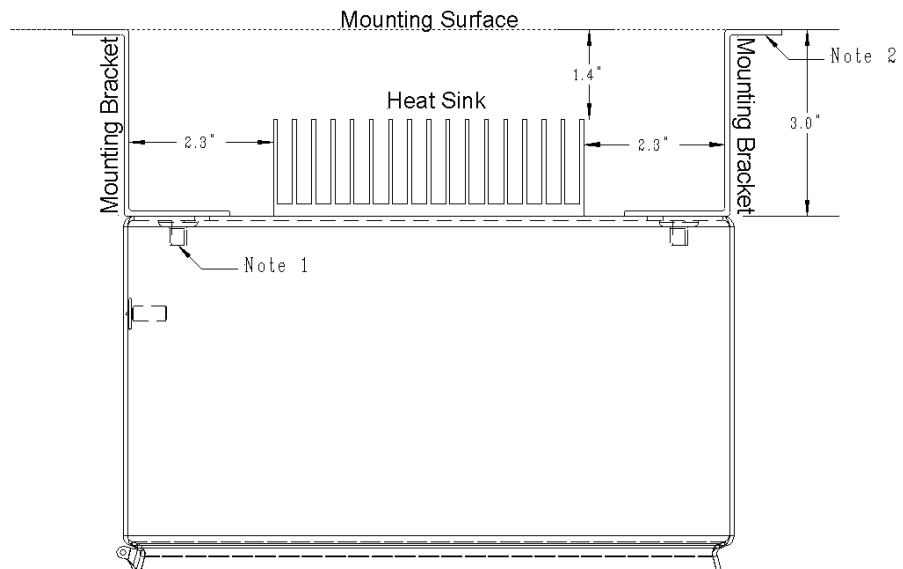

TRACER 2 SS

Bracket Dimensions For Wall Mount – Reference Only

⚠ WARNING

Improper mounting may cause an unsafe condition resulting in equipment damage or failure which could cause personal injury.

Un montage incorrect peut provoquer une condition dangereuse entraînant des dommages matériels ou une défaillance pouvant causer des blessures.

Bracket Orientation:

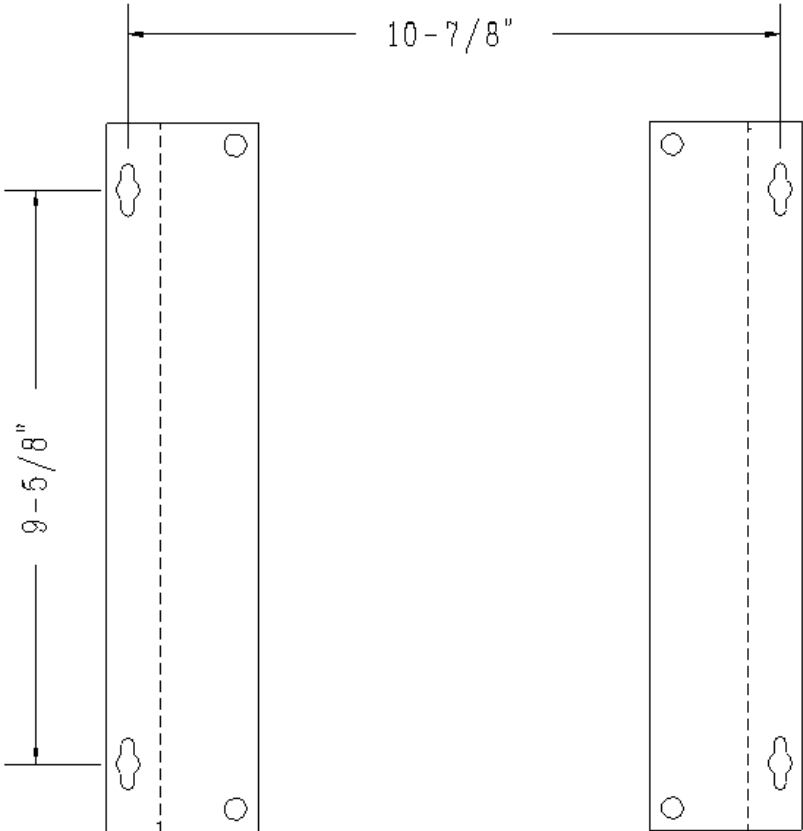

8. Operation

a. Power Board

The **TRACER 2** is available in both 1 circuit and 2 circuit configurations. The product is configured, tested and calibrated at the factory. On 2 circuit devices, each circuit has its own power board. Each power board has its own set of parameter configurations as detailed in this manual.

Each power board has the ability to monitor and alarm based on low process temperature, high process temperature, low load current, high load current, and ground fault current. Operation when fault(s) are present is detailed in a subsequent section of the manual.

b. Controller Board

The **TRACER 2** controller board is also configurable through parameter menu variables. The controller board controls one or both circuits and therefore has only one set of parameter screens. The real time clock calendar, memory, battery backup and display are contained on this board.

The battery is used for providing power to the Real Time Clock Calendar in the event of a power outage. Parametric **TRACER 2** configuration data is stored in nonvolatile memory that does not require the battery, so loss of power will not require system parameter re-configuration.

The battery should be replaced by a certified Electrician before every season or on an annual basis, whichever is shortest. Battery specification:





Manufacturer: Panasonic – BSG
Manufacturer Part Number: CR2032
Description: BATTERY LITHIUM 3V COIN 20MM

9. Navigation









The **TRACER 2** interface contains six keys:

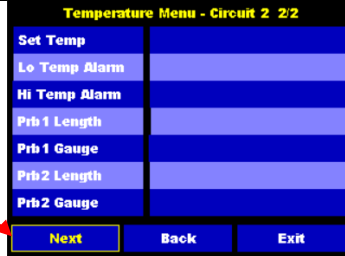

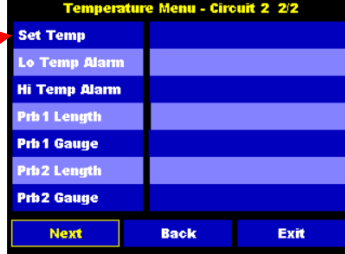

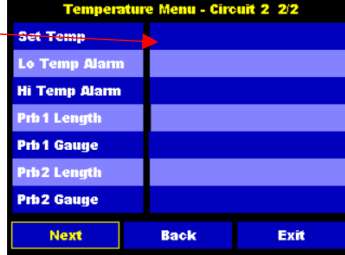



 is used to scroll through the available menus.

Once in a desired menu, use , , ,  to navigate through the fields on the screen. As you navigate through the fields, the selected field(s) will be highlighted.

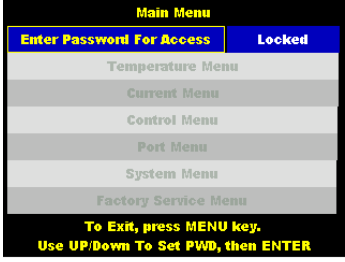
For example:

<p>In this screen, "NEXT" is selected.</p>	
<p>When the desired field is selected,  will select the feature.</p>	
<p>For example, in the screen shown above, depressing  will move to and select the Set Temp field as shown here.</p>	
<p>Pressing the  would select the Set Temp field.</p>	
<p>The  and  arrows will now adjust the Set Temp value. When the desired value is displayed, depressing  will save the value and enable navigation through the fields.</p>	
<p>Note that there is a timeout on all screens. If any screen other than the Default Screen is left idle, the timer will automatically reset to the Default Screen.</p>	

10. Programming

<h2>The Menu Select / Password Screen</h2>	
<p style="text-align: center;"><u>CAUTION:</u></p> <p><i>All programming begins with the selection of items from the Main Menu. After any programming changes are made, it is recommended that the operator resets the unit by cycling power to the device or by pressing the reset switch on the rear of the Display Board (if so equipped).</i></p>	
<p>To begin programming, enter the password by pressing  to enable password entry. Once selected the password field will display "0***". Use  and  to enter a value then . The password field must be correctly populated. Once the value is entered, the password field will show the level of security and the appropriate items will be enabled as follows:</p>	<p>Level "USER" Password = 1111 Allowed access: Temperature Menu</p> <p>Level "INSTALLER" Password = 2222 Allowed access: USER and Current Menu</p> <p>Level "TECHNICIAN" Password = 3333 Allowed access: INSTALLER and Control, Port and System Menus.</p> <p>Level "FACTORY" Password = 2112 Allowed access: TECHNICIAN and Factory</p>
<p>The System Menu will allow modification of the all passwords except for the "FACTORY" password. Once these passwords are changed, the user should document the new pass codes and store them in a secure location.</p> <p style="text-align: center;"></p> <p>When in program screens, the  key will navigate back to the Main Menu in all screens.</p> <p>When in this menu, the screen will time out after no key is pressed for 120 seconds. If the timer expires, the user will be required to re-enter a pass code to gain access to programming menus.</p>	

Temperature Menu

The Temperature Menu defines the set temperature as well as alarm temperatures for the controller as follows:

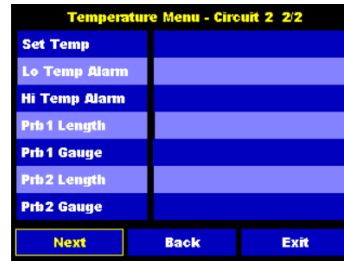

Set Temp

The Set Temp determines the temperature at which the controller will regulate the temperature when the controller is set to On/Off or Proportion mode. The Set Temp is compared to the Actual Temp and if the Actual Temp is less than Set Temp – Hysteresis, the output is energized when in On/Off mode. The output will be Off when Actual Temp is greater than or equal to Set Temp. In proportion mode, the output will be on when below proportion band, will proportion within the proportion band and will be off above set temperature.

Lo Temp Alarm

The Lo Temp Alarm determines the temperature at which the Alarms will be activated. If the Actual Temp is less than the Lo Temp Alarm, the controller will enter an alarm condition. The Lo Temp Alarm may be set to OFF by going one degree below minimum setting.

Hi Temp Alarm

The Hi Temp Alarm determines the temperature at which the Alarms will be activated. If the Actual Temp is greater than the Hi Temp Alarm, the controller will enter an alarm condition. The Hi Temp Alarm may be set to OFF by going one degree above maximum setting.

Prb 1 Length & Prb 1 Gauge

When it is necessary to extend probe lead wire beyond 15 feet, these wire compensation factors are used to ensure proper temperature measurement. Probe lead wire can be between 0 and 250 feet. Lead length is entered to the nearest 10 feet. Wire gauge can be between 22AWG and 12 AWG of stranded copper wire.

Current Menu

The Current Menu defines the output current limits, the GFEP limit, and the GFEP alarm actions for the controller as follows:

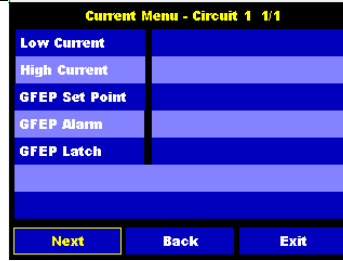

Low Current

The Low Current determines the current at which the low Current alarm will be activated. The current test will run when the load is energized either by heat demand or AUTO CYCLE. If the measured load current is less than Low Current value, the controller will enter an alarm condition.

The Low Current Alarm may be set to OFF by going one key press below minimum setting.

High Current

The High Current determines the current at which the Current alarm will be activated. The current test will run when the load is energized either by heat demand or AUTO CYCLE. If the measured load current is greater than High Current value, the controller will enter an alarm condition.

The High Current Alarm may be set to OFF by going one key press above maximum setting.

GFEP Set Point

The GFEP Set Point determines the fault current through the load loop at which the GFEP Alarm will be activated. If the measured GFEP current is greater than the GFEP Set Point and if the GFEP Alarm is not set to OFF, the controller will enter an alarm condition.

The GFEP Alarm may be set to OFF by going one mA above maximum setting.

Current Menu (continued)	
GFEP Alarm	<p>GFEP Alarm determines the action taken by the controller when a GFEP Alarm is present. The GFEP Alarm can be set to either “Alarm” or “Trip”.</p> <p>When GFEP Alarm is present and set to “Alarm” the controller will display an alarm on the Default Menu and continue operating as normal.</p> <p>When GFEP Alarm is present and set to “Trip” the controller will display an alarm on the Default Menu and the output will be turned OFF.</p>
GFEP Latch	<p>GFEP Latch determines how the GFEP Alarm will be cleared once it has been detected. The GFEP Latch can be set to either “Auto” or “Latch”.</p> <p>When GFEP Latch is set to “Auto”, the GFEP Alarm will automatically clear and the controller will revert to normal operation when GFEP current is less than the GFEP Set Point – 5mA.</p> <p>When GFEP Latch is set to “Latch”, the controller output will remain OFF until the fault is cleared, and a manual reset of the controller is completed.</p>

Control Menu 1

The Control Menu 1 determines how the controller will manage the output load. The parameters act as follows:

Control Menu - Circuit 1		Page 1/2
Control Mode	On / Off	
Hysteresis	2	
Proportion Band	12	
Proportion Time	12	
Capacitive Start	OFF	
Manual Percent	050 %	
<div style="display: flex; justify-content: space-around;"> Next Back Exit </div>		

Control Mode

The Control Mode parameter can be set to “Off”, “Manual”, “On / Off”, or “Proportion”.

When Control Mode is set to “Off”, the output will always be Off except when AUTO CYCLE current and/or GFEP tests if these tests are ON.

When Control Mode is set to “Manual”, the output will be On for the value of Manual Percentage based on a time period of 1 second.

When Control Mode is set to “On / Off”, the Set Temp is compared to the Actual Temp and if the Actual Temp is less than Set Temp – Hysteresis, the output is On. The output will be Off when Actual Temp is greater than or equal to Set Temp.

When Control Mode is set to “Proportion”, the output will proportion based on the proportion band and proportion time parameters.

Hysteresis

The Hysteresis determines the dead band for “On / Off” control mode. Controller will be OFF when sensed temperature is greater than set point and will be ON when temperature drops below Setpoint – Hysteresis.

Proportion Band

The Proportion Band determines the dead band for “Proportion” control mode.

Proportion Time

The Proportion Time determines the time period for “Proportion” control mode.

Control Menu 1 (continued)	
Capacitive Start	When Capacitive Start is set to On and control is in either ON/OFF or PROPORTION mode, the controller will proportion each time the load is energized. The proportioning values will proportion for approximately 100 seconds and will slowly ramp the output using a proprietary algorithm. At the end of 100 seconds, the control will go into either ON/OFF or PROPORTION mode depending on parameter settings.
Manual Percentage	When Control Mode is set to "Manual", the output will be On for the value of Manual Percentage based on a time period of 1 second.

Control Menu 2

The Control Menu 2 determines how the controller will manage the temperature sensors, probe error, and alarm outputs. The parameters act as follows:

Control Menu - Circuit 1		Page 2/2
Sensing Method	Probe 1	
Prb Error Out %	050 %	
DC Alarm Out	Open On Error	
AC Alarm Out	Open On Error	
Next	Back	Exit

Sensing Method

The Sensing Method parameter can be set to “Probe 1”, “Average”, “Low Probe”, or “High Probe”. Circuit 1 has additional options of “Ambient 2”, “Digital I/O”, “Lock Out w/Alarms”, “Lock Out wo/Alarms” options. Circuit 2 has an additional option of Ambient 2”, “Ambient 1”, “Ambient 0”, “Circuit 1 Probe”, “Digital I/O”, “Lock Out w/Alarms”, “Lock Out wo/Alarms” options.

When Sensing Method is set to “Probe 1”, the Actual Temp will be Probe 1.

When Sensing Method is set to “Average”, the Actual Temp will be (Probe 1 + Probe 2) / 2.

When Sensing Method is set to “Low Probe”, the Actual Temp will be the lower value of Probe 1 and Probe 2.

When Sensing Method is set to “High Probe”, the Actual Temp will be the higher value of Probe 1 and Probe 2.

When Sensing Method is set to “Use Circuit 1 Probe”, circuit 2 will use Circuit 1’s probe value.

For “Ambient” settings, please refer to the table in a later section of the manual titled “Sensor Settings Probe Hierarchy” for details on Ambient operation.

For “MINIMUM 3” and “MINIMUM 4” settings, please refer to the table in a later section of the manual titled “Sensor Settings Probe Hierarchy” for details on Ambient operation.

When Digital I/O mode is selected, please refer to the section of the manual titled “Digital I/O Operation”.

For Lock Out w/Alarms and Lock Out wo/alarms, please refer to the section of the manual titled “Lock Out Operation”.

Probe Error Output %

When a probe error is detected with one probe selected, or if two probes are selected and both have errors, the output will be On for the value of Probe Error Output % based on a time period of 1000 milliseconds.

DC Alarm Out

The DC Alarm Out determines the action of the DC Output SSR. The parameter can be set to “Open On Error” or “Close On Error”. If there is any system alarm the output will act as described.

AC Alarm Out

The AC Alarm Out determines the action of the AC Output SSR. The parameter can be set to “Open On Error” or “Close On Error”. If there is any system alarm the output will act as described.

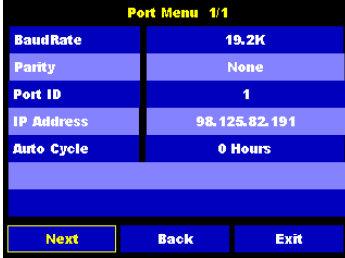
Port Menu	
<p>The Port Menu is used to set communication variables for RS485 (standard) and ethernet (optional) configurations. It is also used to set the Auto Cycle parameter.</p>	
<p>Baud Rate</p>	<p>The Baud Rate parameter can be set to 2.4k,4.8k,9.6k,19.2k,38.4k,56.0k</p>
<p>Parity</p>	<p>The Parity parameter can be set to Even / Odd / None.</p>
<p>Port ID</p>	<p>The Port ID parameter can be set to 0 to 255.</p>
<p>IP Address</p>	<p>The IP Address parameter is a read only parameter established over network.</p>
<p>Auto Cycle</p>	<p>The auto cycle ensures that the Current Limit and GFEP tests are run at least at the interval specified by the user. The AUTO CYCLE can be set to 0 hours (OFF), or from 1 to 999 hours.</p>

System RTCC Menu

The System RTCC Menu is used for setting the real time clock calendar. Hours are set in 12-hour AM/PM format.

System Menu		Page 1/2
Year	2018	
Month	April	
Day Of Month	08	
Day Of Week	Sunday	
Hour	12	
Minute	26	
AM / PM	PM	
Next No Save	Save & Exit	Exit

System Settings and Passwords

The System Settings and Password Menu allows for configuration of the main processor board and saves user configurable passwords.

The parameters act as follows:

System Menu		Page 2/2
Button Chirp	On	
Temp. Scale	°F	
Password Level 1	1111	
Password Level 2	2222	
Password Level 3	3333	
Password Level 4	2112	
Reset To Default	No	
Next	Back	Exit

Button Chirp

The Button Chirp Parameter turns the audible keypad chirp on or off.

Temp. Scale

The Temp Scale parameter sets the unit of measure between Fahrenheit and Celsius.

Password Level 1

The Password Level 1 sets User password.

Password Level 2

The Password Level 2 sets Installer password.

Password Level 3

The Password Level 3 sets Technician password.

Password Level 4

The Password Level 4 is hard coded for Factory Service password.

Reset To Default

When set to "Yes-Use Caution" and enter is pressed, the processor will be re-programmed with default settings. Note all changes will be over written.

11. Parameter Summary and Default Settings

Screen Banner	Item	Use	Default	Min	Max	Other	UOM	
TEMP. MENU	Set Temperature	Target Temperature Set By User	45F/7C	OFF, -80F/-60C	999F/530C		F/C	
TEMP. MENU	Low Temp. Alarm	Low Temperature Alarm	40F/4C	-80F/-60C	999F/530C	Off	F/C	
TEMP. MENU	High Temp. Alarm	High Temperature Alarm	180F/82C	-80F/-60C	999F/530C	Off	F/C	
TEMP. MENU	Probe Length	Sensor Extended Lead Length Compensation	0	0	250		Feet	
TEMP. MENU	Probe Gauge	Sensor Extended Lead Gauge Compensation	24	12,14,16,18,20,22,24			AWG	
CURRENT MENU	Low Current Alarm	Low limit for load current	0.1	0.1	50.0	Off	A	
CURRENT MENU	High Current Alarm	High limit for load current	40.0	0.1	50.0	Off	A	
CURRENT MENU	GFEP Alarm	GFEP Set Point	30.0	30.0	150.0	Off	mA	
CURRENT MENU	GFEP Trip	On GFEP Error Trip or Alarm	Trip	Alarm - Alarm Only No Circuit Trip Trip - Alarm and Trip Circuit				
CURRENT MENU	GFEP Latch	On GFEP Error Latch or Auto	Latch	Auto - reset error and trip when error is resolved Latch - hold error until error is cleared				
CONTROL MENU	Control Mode	Control Operation	On/Off	Off - Controller is Off Manual - Controller 1 to 100% Output On / Off - Automatic operation Proportion - Proportion Operation				
CONTROL MENU	Hysteresis	Dead band for On / Off Control	2	2	100		F & C	
CONTROL MENU	Proportioning Band	Proportion dead band	10	2	100		F & C	
CONTROL MENU	Proportioning Time	Proportion Time	10	2	100		seconds	
CONTROL MENU	Capacitive Start	Slow start for circuit protection	ON	On	Off			
CONTROL MENU	Manual Percent	Percentage On In Manual Mode	50	0	100			
CONTROL MENU	Sensing Method	Determines how sensors are used	Probe 1	Probe 1 - uses PRB1 Average of PRB1 & PRB2 Lower of PRB1 & PRB2 Higher of PRB1 & PRB2 Ambient 2 Minimum 3 (Only Available on Circuit 1) ¹ Minimum 4 (Only Available on Circuit 1) ² Ambient 1 (Only Available on Circuit 2) Ambient 0 (Only Available on Circuit 2) Circuit 1 Probe (Only Available on Circuit 2) Digital I/O ³ Lock Out w/Alarms Lock Out wo/Alarms				
CONTROL MENU CKT	Output On Failed Sensor	Output power when sensor fails	100%	0%	100%	-		
CONTROL MENU CKT	DC Alarm Output On Fault	Determines alarm output configuration	Open On Error	Open On Err	Close On Error		dry contacts	
CONTROL MENU CKT	AC Alarm Output On Fault	Determines alarm output configuration	Open On Error	Open On Err	Closed On Error		dry contacts	
PORT MENU	Baud Rate	Communication rate for serial comm	9.6K	2.4k,4.8k,9.6k,19.2k,38.4k,56.0k				
PORT MENU	Parity	Parity bit for serial comm	None	Even/Odd/None				
PORT MENU	ID	Unique controller address	1	0 to 255				
PORT MENU	IP Address	Internet Protocol Address	Read Only	Read only parameter established over network				
PORT MENU	Auto Cycle	Auto Cycle Test Time	1	0=OFF	99	-	Hours	
SYSTEM MENU	Year	Real Time Clock Calendar	2001					
SYSTEM MENU	Month		January					
SYSTEM MENU	Day Of Month		1					
SYSTEM MENU	Day Of Week		Monday					
SYSTEM MENU	Hour		12					
SYSTEM MENU	Minute		00					
SYSTEM MENU	AM / PM		AM					
SYSTEM MEN	Button Chirp	Turns button chirp on or off	On	On	Off			
SYSTEM MENU	Temperature Scale	Selects degrees F or C	Fahrenheit	F	Celsius			
SYSTEM MENU	Password 1	Password for Setup-USER	1111	1000	9999			
SYSTEM MENU	Password 2	Password for Setup-Installer	2222	1000	9999			
SYSTEM MENU	Password 3	Password for Setup-Technician	3333	1000	9999			
SYSTEM MENU	Password 4	Password for Setup-Factory	----	2112	2112			
SYSTEM MENU	Reset All To Default	Resets all variables to factory default	No	Yes -Use Caution	No			

¹ Only available on 7300-13001-81 Configuration

² Only available on 7300-13001-81 Configuration

³ Digital I/O overrides all Control Modes

12. Security Levels

Navigation Flow Chart for *TRACER2*

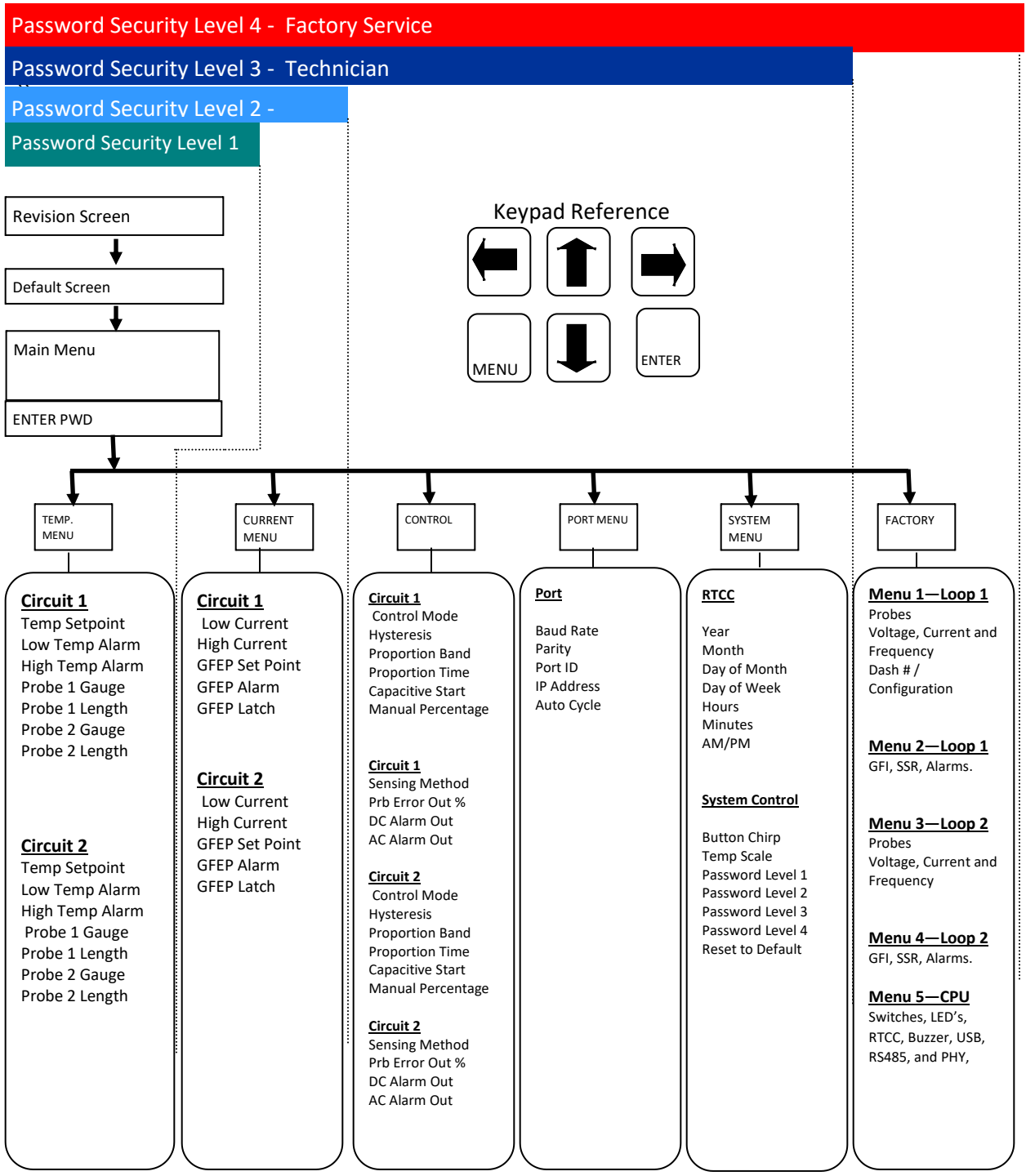

13. Alarms and Error Handling

Temperature Alarms

These alarms run continuously whenever controller is ON and the alarm is not turned OFF:

Alarm Condition	Setting Variable	AC Alarm Out	DC Alarm Out	Alarm LED	Panel Display	Notes
Low Temp. Alarm	Low Temp	Open or Closed depending on parameter: AC Alarm Output	Open or Closed depending on parameter: DC Alarm Output	On	Low Temp Circuit #	Alarm cleared automatically when process temperature falls within limits.
High Temp. Alarm	High Temp	Open or Closed depending on parameter: AC Alarm Output	Open or Closed depending on parameter: DC Alarm Output	On	High Temp Circuit #	Alarm cleared automatically when process temperature falls within limits.

Current Alarms

Output current is tested whenever the output is ON, and once every AUTO CYCLE TIME whenever the alarms are not set to OFF.

Alarm Condition	Setting Variable	AC Alarm Out	DC Alarm Out	Front Panel LED	Front Panel Display	Notes
Low Current Alarm	Low Current	Open or Closed depending on parameter: AC Alarm Output	Open or Closed depending on parameter: DC Alarm Output	On	Low Current Circuit #	Alarm cleared automatically when current falls within limits.
High Current Alarm	High Current	Open or Closed depending on parameter: AC Alarm Output	Open or Closed depending on parameter: DC Alarm Output	On	High Current Circuit #	Alarm cleared automatically when current falls within limits.

GFEP Alarms

Ground Fault Equipment Protection Alarm is continuously tested when output is ON and once every AUTO CYCLE TIME if not set to OFF and operates as follows:

GFEP Alarm Setting	GFEP Latch Setting	Output	Auto Cycle Self-Test if not set to zero	Alarm LED with GFEP Error	Alarm Relays	Notes
Trip	Latch	Off	Disabled	LED blinks and must be manually reset after GFEP error detected	Active and must be manually reset after GFEP error detected	Must Manually reset alarm
Trip	Auto	Regulates Temp.	Enabled	LED Blinks when GFEP error is present.	Active if GFEP active off when output is turned off.	No GFEP Fault detected resets alarm
Alarm	Latch	Regulates Temp.	Enabled	LED blinks and must be manually reset after GFEP error detected	Active and must be manually reset after GFEP error detected	Must Manually reset alarm
Alarm	Auto	Regulates Temp.	Enabled	LED Blinks when GFEP error is present.	Active if GFEP active, off when output is turned off.	No GFEP Fault detected resets alarm

Probe Alarms

Probes are tested continuously whenever controller is ON.

Parameter	Setting	Condition	Front Panel LED	Front Panel Display	SSR Output	AC Alarm Out	DC Alarm Out	Notes
Sensing Method	Digital I/O	Probe 1 Error: Open or Short	None	None	None	None	None	N/A
	Probe 1 & Lockout Modes	Probe 1 Error: Open or Short	Lit	Prb 1 Open or Prb 1 Short Actual Temp. displays "----"	Set output to value in parameter: Probe Error Output %	Open or Closed depending on parameter: AC Alarm Output	Open or Closed depending on parameter: DC Alarm Output	Error resets when probe returns to normal operation.
	Average or Low Probe or High Probe	1 probe error	Lit	Prb X Open or Prb X Short	Normal operation using valid probe.			
		2 probe errors	Lit	Prb X Open or Prb X Short Actual Temp. displays "----"	Set output to value in parameter: Probe Error Output %			
	MINIMUM 3	1 or 2 probe errors		Prb X Open or Prb X Short	Normal operation using valid probe.			
		3 probe errors		Prb X Open or Prb X Short Actual Temp. displays "----"	Set output to value in parameter: Probe Error Output %			
	MINIMUM 4	1, 2 or 3 probe errors		Prb X Open or Prb X Short	Normal operation using valid probe.			
		4 probe errors		Prb X Open or Prb X Short Actual Temp. displays "----"	Set output to value in parameter: Probe Error Output %			
	Ambient	Any Probe error	Lit	Prb X Open or Prb X Short Actual Temp. displays "----"	Set output to value in parameter: Probe Error Output %			

14. Sensor Settings Probe Hierarchy

The following table identifies SENSING METHOD settings and the probe used for process and alarms. It is the responsibility of the installer to properly manage parametric settings and install probes for correct operation. In addition to this table, please review the Alarms and Error Handling section of this manual.

SENSING METHOD		CIRCUIT 1		CIRCUIT 2	
Circuit 1	Circuit 2	PROBE 1	PROBE 2	PROBE 1	PROBE 2
PROBE 1	-	BOTH			
AVERAGE	-	BOTH	BOTH		
LOW PROBE	-	BOTH	BOTH		
HIGH PROBE	-	BOTH	BOTH		
AMBIENT 2	-	PROCESS	ALARM		
MINIMUM 3	-	BOTH	BOTH	BOTH	
MINIMUM 4	-	BOTH	BOTH	BOTH	BOTH
DIGITAL I/O	-	NOT USED	CONTROL		
LOCKOUT	-	BOTH	LOCKOUT		
-	PROBE 1			BOTH	
-	AVERAGE			BOTH	BOTH
-	LOW PROBE			BOTH	BOTH
-	HIGH PROBE			BOTH	BOTH
-	AMBIENT 2			PROCESS	ALARM
-	AMBIENT 1	PROCESS			ALARM
-	AMBIENT 0	PROCESS	ALARM		
-	CIRCUIT 1 PROBE	BOTH			
-	DIGITAL I/O			NOT USED	CONTROL
-	LOCKOUT			BOTH	LOCKOUT

PROCESS = USED FOR PROCESS TEMPERATURE

ALARM = USED FOR ALARM TEMPERATURE

BOTH = USED FOR PROCESS AND ALARM TEMPERATURE

LOCKOUT = USED TO DISABLE LOOP OPERATION

CONTROL = USED TO CONTROL LOOP OPERATION – NO PROBE ERRORS

15. Auto Cycle

The auto cycle ensures that the Current Limit and GFEP tests are run at least at the interval specified by the user. The AUTO CYCLE can be set to 0 hours (OFF), or from 1 to 999 hours.

The GFEP test is always active and will run whenever the output is ON, either by heat demand or AUTO CYCLE test.

The Current Limit test is run every time the current is applied to the load except when Capacitive Start is enabled. In the case of Capacitive start, the Current Limit test will only be run after the Capacitive Start process reaches 100%

Every time the Current Limit test is run, the Auto Cycle timer is reset. This means that it is possible that the Auto Cycle will never activate if in the normal operation:

- 1) Current is applied to the load for a long enough period for the Current Limit test to run if Capacitive start is disabled.
- 2) Current is applied to the load for a long enough period for the Current Limit test to run after Capacitive start has achieved 100% and Capacitive start is enabled

Without Capacitive Start the Auto cycle test will only take a few seconds.

With Capacitive Start the Auto cycle test will complete is > 100 seconds.

16. Circuit Configuration For 1 or 2 Circuit Display

***** CAUTION *****

When changing the configuration number, all parameters must be reset as it is possible for invalid configurations may exist in some circumstances. Always change configuration setting before configuring remaining parameters.

In some installations it may be desirable to use a 2 circuit TRACER 2 as a one circuit device. This is common for critical applications where a spare circuit may be desired or when a future expansion is planned. When using a two circuit TRACER 2 as a 1 circuit device, you may change the display to show only circuit 1. Follow these instructions:

1. Navigate to the "Factory Service Menu" by following instructions in Programming Section of this manual.
2. Select Factory Level Security.
3. Navigate to the system configuration setting ("7300-13001-??").
4. Select the appropriate number using the table shown in the Models And Part Numbers section of this manual.

17. DIGITAL I/O Operation

When Digital I/O Operation is selected, the TRACER 2 monitors the PROBE 2 input. Connect a dry contact to Probe 2 pins 1 and 3 (please refer to Wiring Diagrams in the manual for connection details). Caution should be used to ensure that the connected device is an open / close switch contact with no voltage or current applied. Failure to do so may harm the TRACER 2 device and void warranty. Multiple TRACER 2 loops can have the Probe 2 input connected in parallel. Caution should be taken to keep all pins connected correctly. Failure to do so may harm the TRACER 2 device and void warranty.

When DIGITAL I/O operation is selected the TRACER 2 will read Probe 2 input. If the remote switch connected to Probe 2 is closed (See Note 1), the TRACER 2 output will be on and the Actual Temperature field will display "On". If the remote switch connected to Probe 2 is open (See Note 2), the TRACER 2 output will be off and the Actual Temperature field will display "Off". If Circuit 2 is set to "Circuit 1 Probe", circuit 2 will operate from Circuit 1 inputs.

In this mode, no temperature sensor is used. Low temperature and High Temperature Alarms will be disabled.

Note 1: The input resistance of the switch and wire connected to PROBE 2 must be less than 50 Ohms when closed. So maximum distance when using 22AWG wire is approximately 1500 feet.

Note 2: Digital input will be considered open when resistance connected to PROBE 2 is greater than 60 Ohms.

18. Lock Out Operation

When Lock Out w/Alarms or Lock Out wo/alarms operation is selected, the TRACER 2 monitors Probe 2. Connect a dry contact to Probe 2 pins 1 and 3 (please refer to Wiring Diagrams in the manual for connection details). Caution should be used to ensure that the connected device is an open / close switch contact with no voltage or current applied. Failure to do so may harm the TRACER 2 device and void warranty.

When Lock Out w/Alarms or Lock Out wo/alarms operation is selected the TRACER 2 will read the Probe 2 input. If Probe 2 is closed (See Note 1), the TRACER 2 will operate normally and control temperature using the process temperature measured on PROBE 1. If the remote switch connected to Probe 2 is open (see Note 2), the TRACER 2 will turn the output off and display "LOCKED" in the actual temperature field.

When Lock Out w/Alarms is selected, all temperature alarms will operate as specified in the TRACER 2 operating manual and in accordance with user parametric settings.

When Lock Out wo/alarms is selected, the low temperature alarm and high temperature alarm will work normally when the unit is not "LOCKED", and when the unit is "LOCKED" the low temperature and high temperature alarms will be disabled.

Note 1: The input resistance of the switch and wire connected to PROBE 2 must be less than 50 Ohms when closed. So maximum distance when using 22AWG wire is approximately 1500 feet.

Note 2: Digital input will be considered open when resistance connected to PROBE 2 is greater than 60 Ohms.

19. Special 2 Circuit Configuration for 7300-13001-81

***** CAUTION *****

When changing the configuration number, all parameters must be reset as it is possible for invalid configurations may exist in some circumstances. Always change configuration setting before configuring remaining parameters.

In some installations it may be desirable to use a 2 circuit TRACER 2 as a one circuit device with all four available probes measuring a minimum temperature of either 3 or 4 of the probes. To select this special configuration, you must have a 2 circuit TRACER 2 set to 7300-1300-?? = 81. This is set using the Factory Service screen. To change this option:

1. Navigate to the “Factory Service Menu” by following instructions in Programming Section of this manual.
2. Select Factory Level Security.
3. Navigate to the system configuration setting (“7300-13001-??”).
4. Select 81 option.

Once this option is set, the Sensing Method in the Control Menu – Circuit 1 will reveal two additional options called Minimum 3 and Minimum 4. If these options are selected, the TRACER 2 will use the lowest probe temperature as the Actual Temperature. When Minimum 3 is selected, Circuit 1 Probes 1 and 2 and Circuit 2 Probe 1 will be active. When Minimum 4 is selected all four probes will be active.

20. Mechanical Drawing

Dimensions						
	Unit	A	B	H	W	D
TRACER 2	Inch	1.8	3.0	10.5	8.5	8.1
	cm	4.4	7.6	26.7	21.6	20.4
TRACER 2 SS	Inch	1.8	3.0	11.8	9.8	7.7
	cm	4.4	7.6	30.0	25.0	19.6

file: InstallationDrawing.CAD

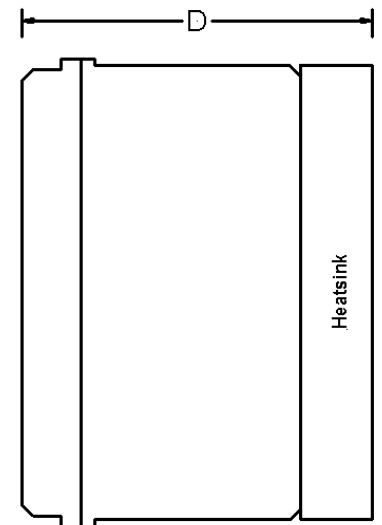
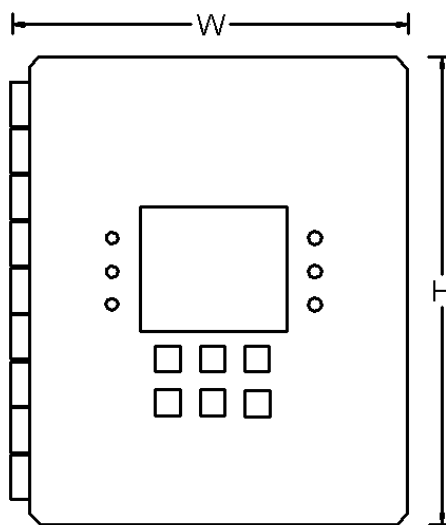
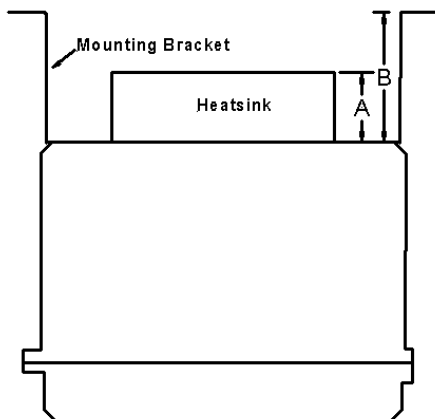

21. Technical Specifications

Item	Value
Voltage	120-240,277VAC, 50/60Hz
Power Supply	Bias Power BPWX 4-14-00 AC/DC Power Modules 4W 14V SINGLE 90-308V Extreme Temp
SSR Output	Solid State Relays - Industrial Mount 50A 480VAC DC
Output Current Rating	30 A per circuit
Number Of Circuits	1 or 2
Operating Ambient Temperature	-35°F to 104°F (-35°C to +40°C)
Electronics Power Consumption	6VA
Electronics Fuse Protection	FUSE CERAMIC 1A 500VAC 400VDC 5mm x 20mm
Pollution Rating	Degree 4 / 2 (2 refers to the environment within the outdoor enclosure)
Temperature Sensor(s)	3 wire PRTD 100 Ω @ 0°C .00385 Ω/Ω°C
Number Of Sensors Per Circuit	1 or 2
AC Alarm SSR (Option: Verify Model Number)	1.8A 12-240VAC
DC Alarm SSR (Option: Verify Model Number)	1.8A 0-50VDC
Mechanical Alarm Relay (Option: Verify Model Number)	1.8A, 240 VAC, 50/60Hz 1.8A, 80 VDC
Battery	CR2032
LED 2 on Power Board	DC Board Power (Fused Output)
LED 7 on Power Board	AC Power Indicator
Protection Rating	IEC IP66
TRACER 2 Enclosure Rating	NEMA 4X FG. Suitable for Indoor or Outdoor Applications (unit employs 4X enclosure)
TRACER 2SS Enclosure Rating	NEMA 4X SS. Suitable for Indoor or Outdoor Applications (unit employs 4X enclosure)
Purpose	Multi-Use Industrial Thermostat (Operating Control – Non-safety related)
Impulse Voltage	4kV
Construction	Independently Mounted
UL	UL/cULus Ordinary Class 1 Division 2 Groups A,B,C,D Hazardous Locations (UL file E508882)

22. Torque Specifications

Item	Value
Torque Value for Power Terminal Block Connections	11-15 in-lbs.
Torque Value for TRACER 2 Mounting Brackets	28-34 in-lbs.
Torque Value for TRACER 2 SS Mounting Brackets	27-33 in-lbs.
Torque Value for Alarm and Sensor Terminal	3.1 – 3.5 in. lbs. (.35 to .4 Nm)
Power Terminal Block AWG Range	6-18 AWG
Alarm, Sensor and Comm. Terminal Block Range	12 – 24 AWG
Load 30A	10 AWG Wire
Load 20A	12 AWG Wire
Load 15A	14 AWG Wire

23. Panel & Display Board Layout

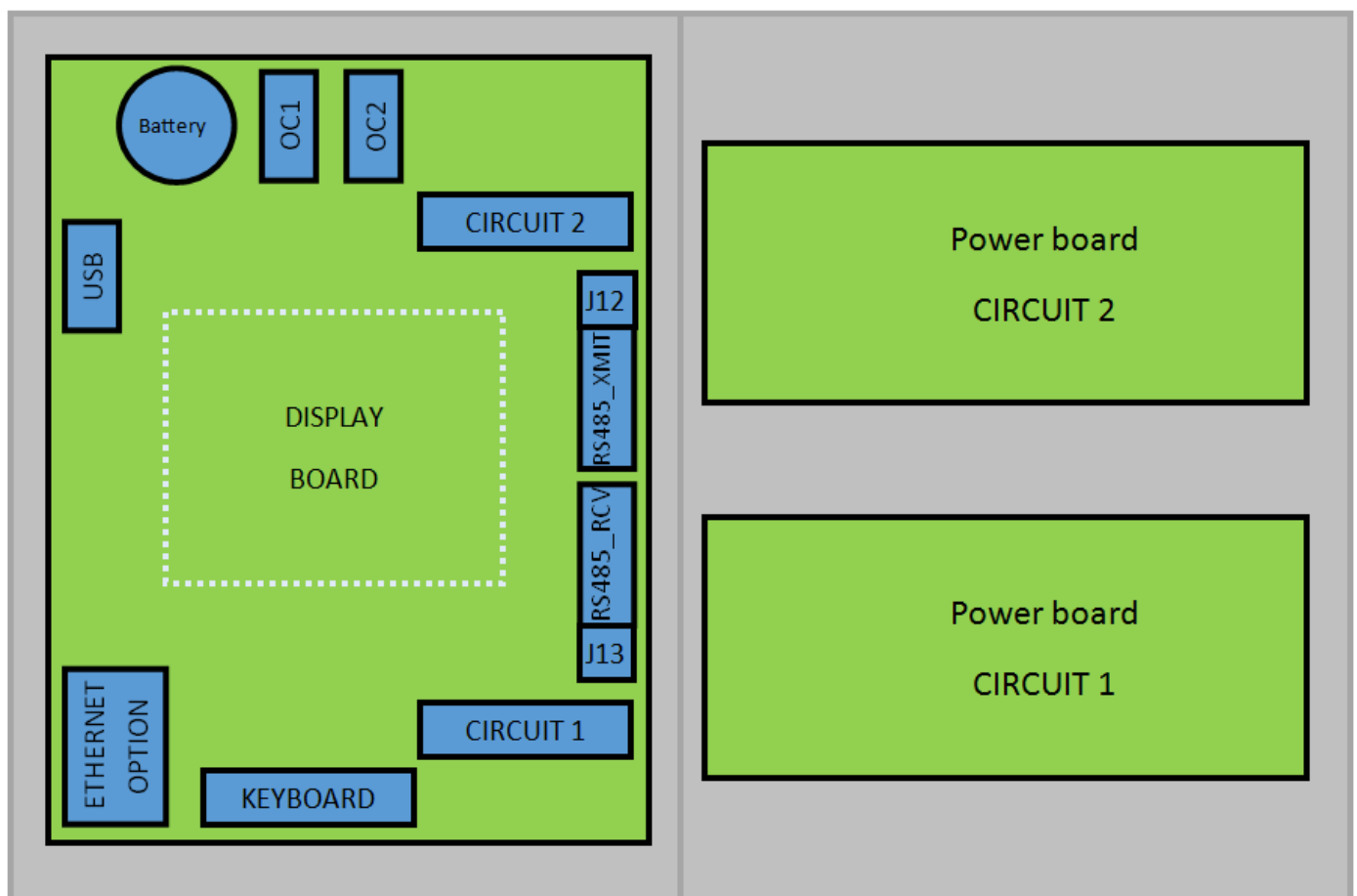

24. Power Board Layout and Wiring Diagrams

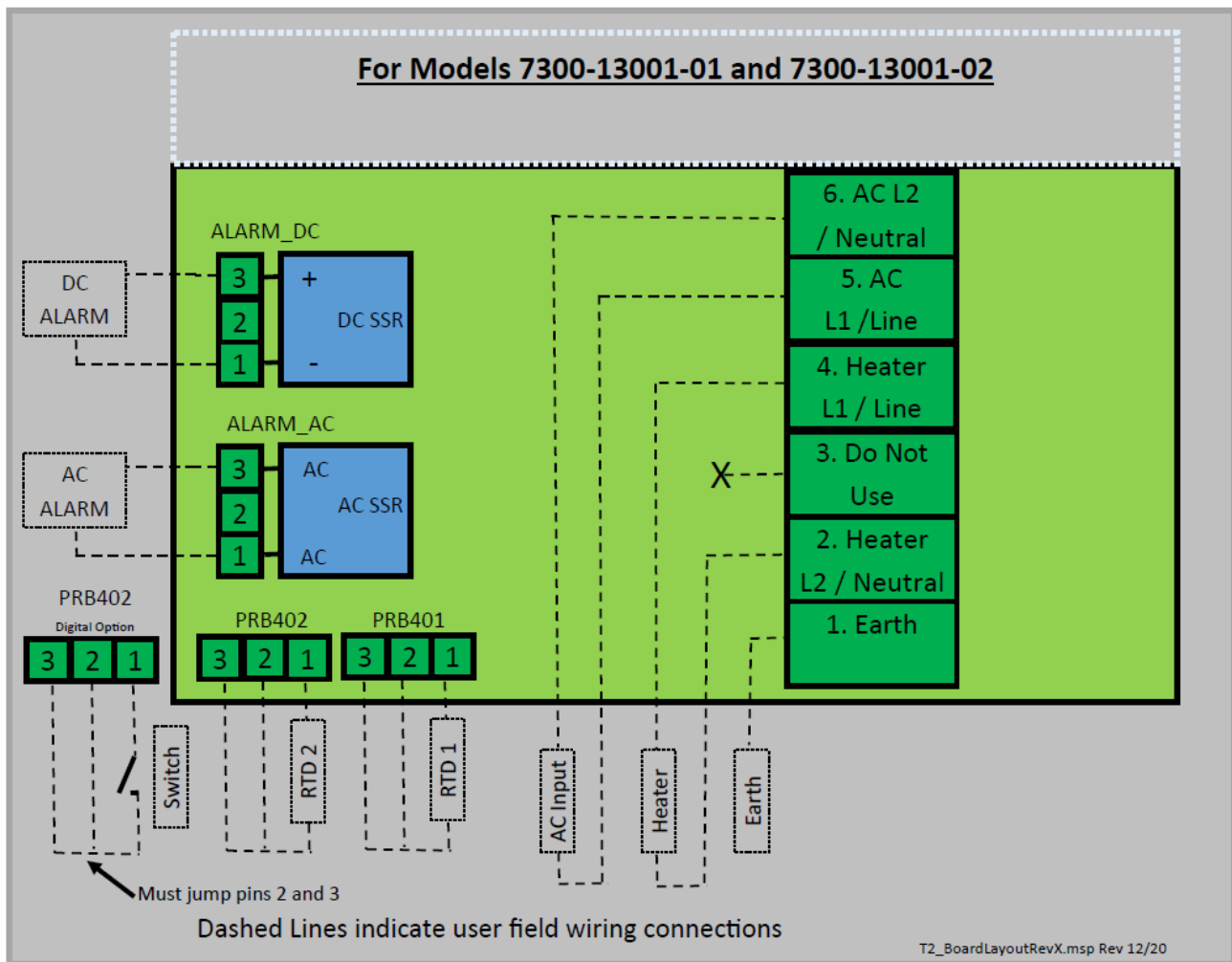

For Models 7300-13001-03 and 7300-13001-04

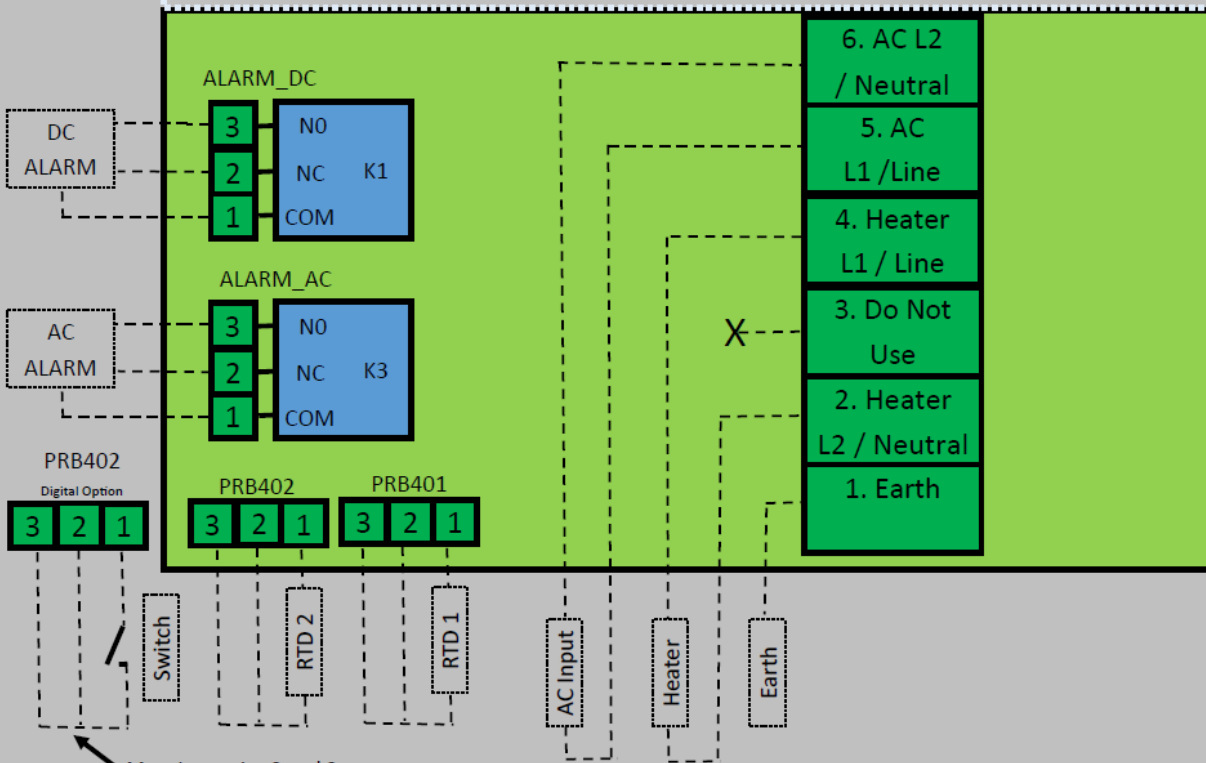

T2_BoardLayoutRevX.msp Rev 12/20

For Models 7300-13001-07 and 7300-13001-08

120VAC and 277VAC circuit configuration

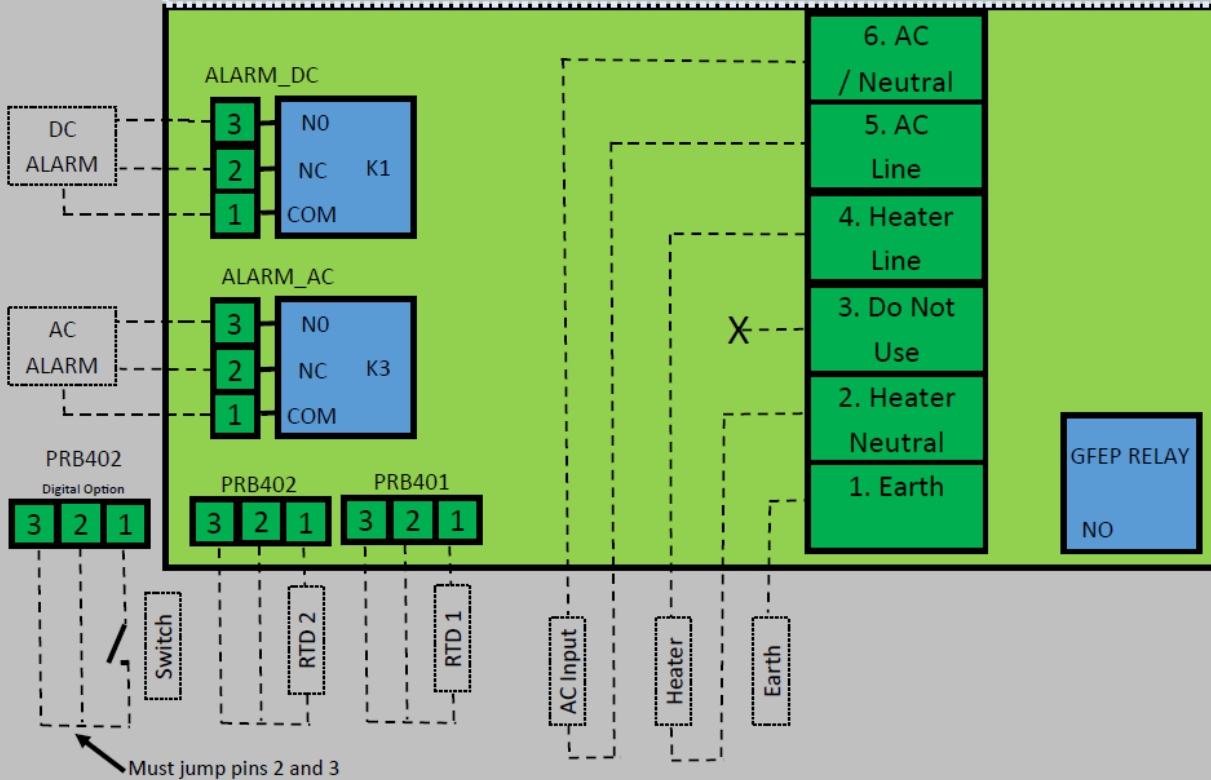

Dashed Lines indicate user field wiring connections

T2_BoardLayoutRevX.msp Rev 12/20

For Models 7300-13001-07 and 7300-13001-08

208VAC and 240VAC circuit configuration

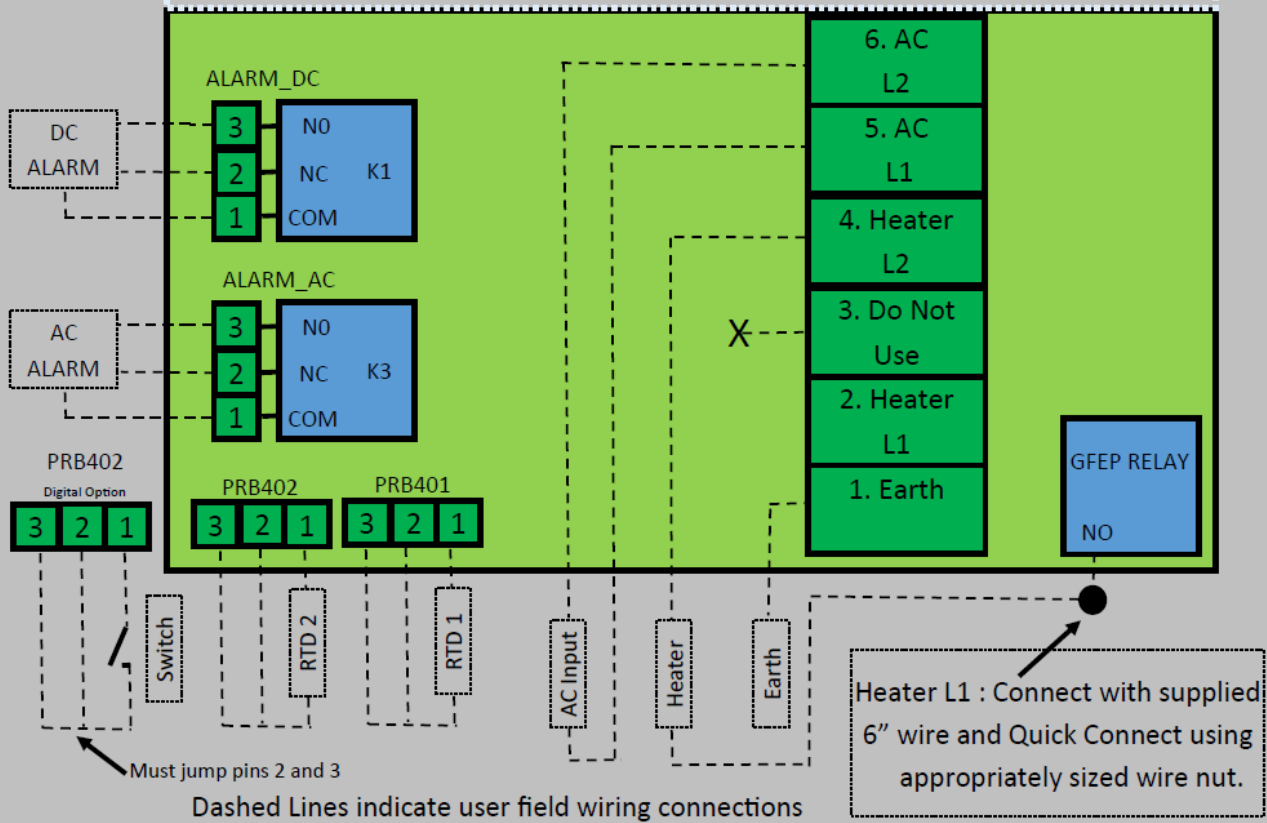

25. Digital I/O Wiring Diagram

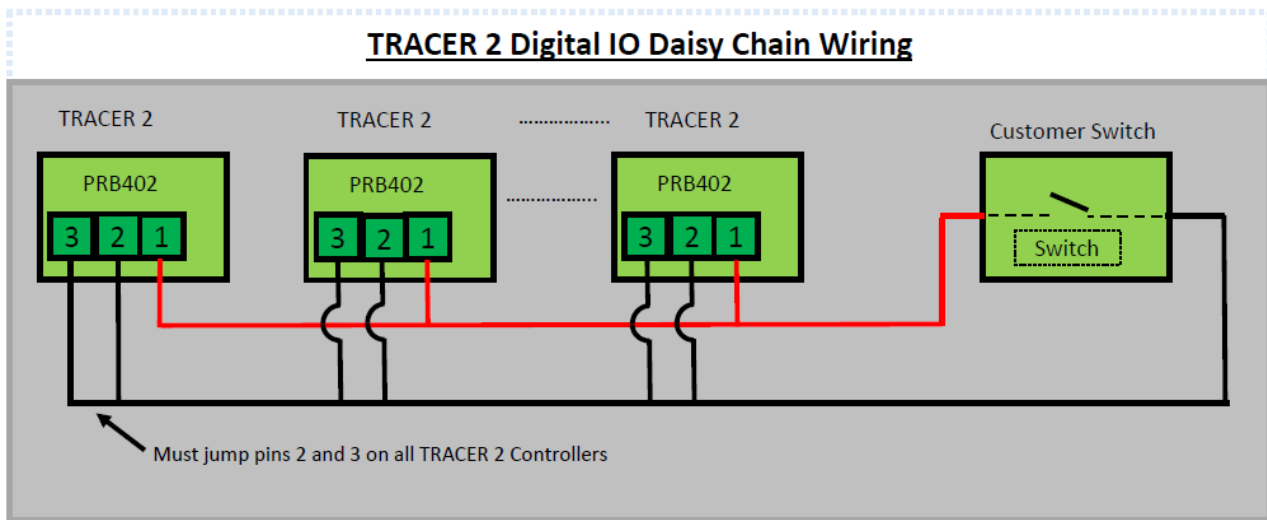

26. Modbus

The **TRACER 2** supports Modbus communications via RS485 interface 2 or 4 wire communications. For detailed explanations of Modbus, please refer to:

http://www.modbus.org/docs/Modbus_Application_Protocol_V1_1b3.pdf

The data in this manual is particular to the **TRACER 2** product.

Physical Layer

The Base address, bit rate and character format are configured via the factory service menu.

Physical layer configuration settings possible are:

- Data rate: 2400, 4800, 9600 (default), 19200, 38400, 56000 bps
- Parity: None (default), Even, Odd
- Addresses: 0 to 255 (default = 1)
- Character format: Always 8 bits per character.

Wiring Schematic / Photograph:

Wiring Schematic	CPU Board Photograph
<p>BoardLayoutRevA.msp</p>	
<p>Wire AWG: 12-24 Wire Type: Twisted Pair Shielded Cable Is Strongly recommended Recommended Maximum Wire Length: 2000 feet. If more than 2000 feet is required, please consult factory.</p>	

Supported Modbus Function Codes as follows:

01 (0x01) Read Coils

This function code is used to read from 1 to 2000 contiguous status of coils in a remote device. The Request PDU specifies the starting address, i.e., the address of the first coil specified, and the number of coils. In the PDU Coils are addressed starting at zero. Therefore, coils numbered 1-16 are addressed as 0-15. The coils in the response message are packed as one coil per bit of the data field. Status is indicated as 1= ON and 0= OFF. The LSB of the first data byte contains the output addressed in the query. The other coils follow toward the high order end of this byte, and from low order to high order in subsequent bytes.

Request

Slave Address	1 Byte	0 - 255
Function code	1 Byte	1
Starting Address	2 Bytes	0 - 65535
Quantity of Coils	2 Bytes	1 to 2000
CRC	2 Bytes	0 - 65535

Response

Slave Address	1 Byte	0 - 255
Function code	1 Byte	1
Byte count	1 Byte	N*
Coil Status	n Byte	n = N or N + 1
CRC	2 Bytes	0 - 65535

*N = Quantity of Input

01 (0x01) Read Coils Address Map & Description

<u>Data Address</u>	<u>Hex Address</u>	<u>Description</u>
0	0x0000	AC Alarm Circuit 1 (0 = OFF, 1 = ON)
1	0x0001	DC Alarm Circuit 1 (0 = OFF, 1 = ON)
2	0x0002	AC Alarm Circuit 2 (0 = OFF, 1 = ON)
3	0x0003	DC Alarm Circuit 2 (0 = OFF, 1 = ON)
4	0x0004	Circuit 1 SSR Heater Output (0 = OFF, 1 = ON)
5	0x0005	Circuit 2 SSR Heater Output (0 = OFF, 1 = ON)
6	0x0006	Circuit 1 Dry Contact (0 = Open, 1 = Closed) ⁴
7	0x0007	Circuit 2 Dry Contact (0 = Open, 1 = Closed) ⁵
8- 65535	0x008 – 0xFFFF	Reserved

⁴ Will read 0 (zero) if not used for control.

⁵ Will read 0 (zero) if not used for control.

02 (0x02) Read Discrete Inputs

This function code is used to read from 1 to 2000 contiguous status of discrete inputs in a remote device. The Request PDU specifies the starting address, i.e., the address of the first input specified, and the number of inputs. In the PDU Discrete Inputs are addressed starting at zero. Therefore, Discrete inputs numbered 1-16 are addressed as 0-15. The discrete inputs in the response message are packed as one input per bit of the data field. Status is indicated as 1= ON; 0= OFF. The LSB of the first data byte contains the input addressed in the query. The other inputs follow toward the high order end of this byte, and from low order to high order in subsequent bytes. If the returned input quantity is not a multiple of eight, the remaining bits in the final data byte will be padded with zeros (toward the high order end of the byte). The Byte Count field specifies the quantity of complete bytes of data.

Request

Slave Address	1 Byte	0 - 255
Function code	1 Byte	2
Starting Address	2 Bytes	0 - 65535
Quantity of Inputs	2 Bytes	1 to 2000 (0x07D0)
CRC	2 Bytes	0 - 65535

Response

Slave Address	1 Byte	0 - 255
Function code	1 Byte	2
Byte count	1 Byte	N*
Input Status	N* x 1 Byte	
CRC	2 Bytes	0 - 65535

*N = Quantity of Inputs / 8 if the remainder is different of 0 \Rightarrow N = N+1

02 (0x02) Read Discrete Inputs Address Map & Description

<u>Data Address</u>	<u>Hex Address</u>	<u>Description</u>
0	0x0000	Probe 1 Circuit 1 Error (0 = NO ERROR, 1 = ERROR)
1	0x0001	Probe 2 Circuit 1 Error (0 = NO ERROR, 1 = ERROR)
2	0x0002	Probe 1 Circuit 2 Error (0 = NO ERROR, 1 = ERROR)
3	0x0003	Probe 2 Circuit 2 Error (0 = NO ERROR, 1 = ERROR)
4	0x0004	Temperature Alarm Circuit 1 (0 = NO ALARM, 1 = ALARM)
5	0x0005	Temperature Alarm Circuit 2 (0 = NO ALARM, 1 = ALARM)
6	0x0006	Current Alarm Circuit 1 (0 = NO ALARM, 1 = ALARM)
7	0x0007	Current Alarm Circuit 2 (0 = NO ALARM, 1 = ALARM)
8	0x0008	GFEP Alarm Circuit 1 (0 = NO ALARM, 1 = ALARM)
9	0x0009	GFEP Alarm Circuit 2 (0 = NO ALARM, 1 = ALARM)
10- 65535	0x010 – 0xFFFF	Reserved

04 (0x04) Read Input Registers

This function code is used to read from 1 to 125 contiguous input registers in a remote device. The Request PDU specifies the starting register address and the number of registers. In the PDU Registers are addressed starting at zero. Therefore, input registers numbered 1-16 are addressed as 0-15. The register data in the response message are packed as two bytes per register, with the binary contents right justified within each byte. For each register, the first byte contains the high order bits and the second contains the low order bits.

Request

Slave Address	1 Byte	0 - 255
Function code	1 Byte	4
Starting Address	2 Bytes	0 - 65535
Quantity of Input Registers	2 Bytes	1 to 125 (0x007D)
CRC	2 Bytes	0 - 65535

Response

Slave Address	1 Byte	0 - 255
Function code	1 Byte	4
Byte count	1 Byte	2 x N*
Input Registers	N* x 2 Bytes	
CRC	2 Bytes	0 - 65535

*N = Quantity of Input

04 (0x04) Read Input Registers Address Map & Description

Data Address	Hex Address	Description
0	0x0000	Actual Temperature Circuit 1 – Integer Degrees F
1	0x0001	Set Temperature Circuit 1 – Integer Degrees F
2	0x0002	Load Circuit 1 – Fixed in Tenths Of Amps (ex. 101 = 10.1A)
3	0x0003	Control Mode Circuit 1 – 0=OFF, 1=ON/OFF 2=PROPORTION 3=Manual
4	0x0004	GFEP Current Circuit 1 – Integer mA (ex. 100 = 100mA)
5	0x0005	Actual Temperature Circuit 2 – Integer Degrees F
6	0x0006	Set Temperature Circuit 2 – Integer Degrees F
7	0x0007	Load Circuit 2 – Fixed in Tenths Of Amps (ex. 101 = 10.1A)
8	0x0008	Control Mode Circuit 2 – 0=OFF, 1=ON/OFF 2=PROPORTION 3=Manual
9	0x0009	GFEP Current Circuit 2 - Integer mA (ex. 100 = 100mA)
10- 65535	0x014 – 0xFFFF	Reserved

06 (0x06) Write Single Register

This function code is used to write a single holding register in a remote device. The Request PDU specifies the address of the register to be written. Registers are addressed starting at zero. Therefore, register numbered 1 is addressed as 0. The normal response is an echo of the request, returned after the register contents have been written. All control via MODBUS is volatile and should be re-initialized by the MODBUS master when power is cycled.

Request

Slave Address	1 Byte	0 - 255
Function code	1 Byte	6
Register Address	2 Bytes	0 - 65535
Register Value	2 Bytes	0 - 65535
CRC	2 Bytes	0 - 65535

Response

Slave Address	1 Byte	0 - 255
Function code	1 Byte	6
Register Address	2 Bytes	0 - 65535
Register Value	2 Bytes	0 - 65535
CRC	2 Bytes	0 - 65535

06 (0x06) Write Single Register Address Map & Description

Data Address	Hex Address	Item	Values
0	0x0000	Set Temperature - Circuit 1	-80F to 999F integer
1	0x0001	Low Temp. Alarm - Circuit 1	-80F to 999F integer ⁶
2	0x0002	High Temp. Alarm - Circuit 1	-80F to 999F integer ⁷
3	0x0003	Low Current Alarm - Circuit 1	.1 A to 50.0A in tenths fixed width (ex 25.1A = 251) ⁸
4	0x0004	High Current Alarm - Circuit 1	.1 A to 50.0A in tenths fixed width (ex 25.1A = 251) ⁹
5	0x0005	GFEP Setpoint - Circuit 1	30.0ma to 150.0ma in tenths fixed width (ex 150.0mA = 1500) ¹⁰
6	0x0006	GFEP Trip - Circuit 1	0 = Alarm - Alarm Only No Circuit Trip
			1 = Trip - Alarm and Trip Circuit
7	0x0007	GFEP Latch - Circuit 1	0 = Auto - reset error and trip when error is resolved
			1 = Latch - hold error until error is cleared

⁶ The Low Temperature Alarm can only be set to off via the Front Panel. To effectively turn off the Low Temperature Alarm remotely, set this value to the maximum value.

⁷ The High Temperature Alarm can only be set to off via the Front Panel. To effectively turn off the High Temperature Alarm remotely, set this value to the minimum value.

⁸ The Low Current Alarm can only be set to off via the Front Panel. To effectively turn off the Low Current Alarm remotely, set this value to the maximum value.

⁹ The High Current Alarm can only be set to off via the Front Panel. To effectively turn off the High Current Alarm remotely, set this value to the minimum value.

¹⁰ The GFEP Setpoint can only be set to off via the Front Panel. Use caution when changing this register.

Data Address	Hex Address	Item	Values
8	0x0008	Control Mode - Circuit 1	0 - Controller is Off
			1 = Manual - Controller 1 to 100% Output
			2 = On / Off - Automatic operation
			3 = Proportion - Proportion Operation
9	0x0009	Hysteresis - Circuit 1	2F to 100F integer
10	0x000A	Proportioning Band - Circuit 1	2F to 100F integer
11	0x000B	Proportioning Time - Circuit 1	2 to 100 seconds integer
12	0x000C	Capacitive Start - Circuit 1	0= NO, 1=YES
13	0x000D	Manual Percent - Circuit 1	0% to 100% integer 0=OFF, 100=ON
Data Address	Hex Address	Item	Values
14	0x000E	Sensing Method - Circuit 1	0 = Single - uses PRB1
			1 = Average of PRB1 & PRB2
			2 =- Lower of PRB1 & PRB2
			3 = Higher of PRB1 & PRB2
			4 = Ambient 2
			5 = Minimum 3
			6 = Minimum 4
			10 = Digital I/O
			11 = Lockout w/Alarms
			12 = Lockout wo/Alarms
15	0x000F	Output On Failed Sensor - Circuit 1	0% to 100% integer 0=OFF, 100=ON
16	0x0010	DC Alarm Output On Fault - Circuit 1	0 = OPEN ON FAULT, 1 = CLOSE ON FAULT
17	0x0011	AC Alarm Output On Fault - Circuit 1	0 = OPEN ON FAULT, 1 = CLOSE ON FAULT
18	0x0012	Set Temperature - Circuit 2	-80F to 999F integer
19	0x0013	Low Temp. Alarm - Circuit 2	-80F to 999F integer
20	0x0014	High Temp. Alarm - Circuit 2	-80F to 999F integer
21	0x0015	Low Current Alarm - Circuit 2	.1 A to 50.0A in tenths fixed width (ex 25.1A = 251)
22	0x0016	High Current Alarm - Circuit 2	.1 A to 50.0A in tenths fixed width (ex 25.1A = 251)
23	0x0017	GFEP Setpoint - Circuit 2	30.0ma to 150.0ma in tenths fixed width (ex 150.0mA = 1500)
24	0x0018	GFEP Trip - Circuit 2	0 = Alarm - Alarm Only No Circuit Trip
			1 = Trip - Alarm and Trip Circuit
25	0x0019	GFEP Latch - Circuit 2	0 = Auto - reset error and trip when error is resolved
			1 = Latch - hold error until error is cleared
26	0x001A	Control Mode - Circuit 2	0 - Controller is Off
			1 = Manual - Controller 1 to 100% Output
			2 = On / Off - Automatic operation
			3 = Proportion - Proportion Operation
27	0x001B	Hysteresis - Circuit 2	2F to 100F integer
28	0x001C	Proportioning Band - Circuit 2	2F to 100F integer
29	0x001D	Proportioning Time - Circuit 2	2 to 100 seconds integer
30	0x001E	Capacitive Start - Circuit 2	0= NO, 1=YES
31	0x001F	Manual Percent - Circuit 2	0% to 100% integer 0=OFF, 100=ON

Data Address	Hex Address	Item	Values
32	0x0020	Sensing Method - Circuit 2	0 = Single - uses PRB1
			1 = Average of PRB1 & PRB2
			2 = Lower of PRB1 & PRB2
			3 = Higher of PRB1 & PRB2
			4 = Ambient 2
			7 = Ambient 1
			8 = Ambient 0
			9 = Use Circuit 1 Probe for Circuit 2
			10 = Digital I/O
			11 = Lockout w/Alarms
			12 = Lockout wo/Alarms
33	0x0021	Output On Failed Sensor - Circuit 2	0% to 100% integer 0=OFF, 100=ON
34	0x0022	DC Alarm Output On Fault - Circuit 2	0 = OPEN ON FAULT, 1 = CLOSE ON FAULT
35	0x0023	AC Alarm Output On Fault - Circuit 2	0 = OPEN ON FAULT, 1 = CLOSE ON FAULT
36	0x0024	Reserved For Factory	Reserved For Factory
37	0x0025	Reserved For Factory	Reserved For Factory
38	0x0026	ID	0 to 255 ** CAUTION** Changes to port ID (MODBUS address) take effect immediately and corresponding changes to the MODBUS master will be required before communication can resume. Changes will also be saved to EEPROM immediately.
39	0x0027	Button Chirp	0 = OFF, 1 = ON
40	0x0028	Save Loop 1 Settings To EEPROM	0 = NO, 1 = YES
41	0x0029	Save Loop 2 Settings To EEPROM	0 = NO, 1 = YES
42	0x002A	Save System Settings To EEPROM	0 = NO, 1 = YES

27. BacNet

Not implemented in software. Hardware contains RS485 interface 2 or 4 wire. Contact factory for available optional BacNet converters.

28. Ethernet

Contact factory for available optional Ethernet interface.

29. Service Information

TRACER 2 products are warranted against defective material and workmanship for a period of one year from date of shipment. This warranty is limited to the repair or replacement of products at the factory. Under no circumstances does any responsibility extend to apparatus other than its own manufacture. All products are factory-calibrated and adjusted, unauthorized tampering other than field wiring voids the warranty. This warranty applies only to products purchased directly from an authorized distributor.

30. Boot loading New Firmware into *TRACER2*

Please use these instructions to update the controller. You will need to purchase an update kit:

Part Number: 6400-00002-00

Description: USB FIRMWARE UPDATE KIT (TRACER2 USB STICK, SOFTWARE, AND MANUAL)

1. Updating firmware in the field via the USB bootloader
 - a. Updating firmware in the field is a 5-step process:
 - i. Ensure that the USB Stick supplied contains the file ("T2IMAGE.hex").
 - ii. Insert the USB flash drive into the USB (Type A) port on the Controller Board.
 - iii. Navigate to the "Factory Service Menu"
 - iv. Navigate to the system configuration setting ("7300-13001-??")
 - v. Press enter until the "Boot Load" option appears.
 - vi. Press and hold the left arrow key, then press the down arrow key.
 1. The display will go blank for a few seconds while the firmware is updating.
 2. Once the display goes blank, release the left arrow key.
 3. Once the firmware is updated the system will re-start with the new revision firmware.

31. Factory Service Menus

FACTORY MENU 1 - L1	Probe 1	A2D, °C, °F
FACTORY MENU 1 - L1	Probe 2	A2D, °C, °F
FACTORY MENU 1 - L1	Voltage	Measured Line Voltage
FACTORY MENU 1 - L1	Current	Measured Line Current
FACTORY MENU 1 - L1	Frequency	Measured Line Frequency
FACTORY MENU 1 - L1	7300-13001-??	Dash Number for System Configuration & Bootloader
FACTORY MENU 2 - L1	SSR/OC Output Toggle	Toggle SSR/OC Output
FACTORY MENU 2 - L1	GFI Button Toggle	Toggle GFI Test, Display Leakage Current
FACTORY MENU 2 - L1	DC Alarm Toggle	Toggle DC Alarm / K1. Display status.
FACTORY MENU 2 - L1	AC Alarm Toggle	Toggle AC Alarm. Display status.
FACTORY MENU 3 - L2	Probe 1	A2D, °C, °F
FACTORY MENU 3 - L2	Probe 2	A2D, °C, °F
FACTORY MENU 3 - L2	Voltage	Measured Line Voltage
FACTORY MENU 3 - L2	Current	Measured Line Current
FACTORY MENU 3 - L2	Frequency	Measured Line Frequency
FACTORY MENU 4 - L2	SSR/OC Output Toggle	Toggle SSR/OC Output
FACTORY MENU 4 - L2	GFI Button	Toggle GFI Test, Display Leakage Current
FACTORY MENU 4 - L2	DC Alarm Toggle	Toggle DC Alarm / K1. Display status.
FACTORY MENU 4 - L2	AC Alarm Toggle	Toggle AC Alarm. Display status.
FACTORY MENU 5 CPU	RTCC Display	Displays current RTCC values
FACTORY MENU 5 CPU	LED Test	Read SW, toggle LED. Display SW and LED status.
FACTORY MENU 5 CPU	Buzzer Test	Toggle Buzzer, Display buzzer status.
FACTORY MENU 5 CPU	Pot (R44)	Display R44 value in percentage.
FACTORY MENU 5 CPU	USB Test	Not active
FACTORY MENU 5 CPU	RS485 Test	Not active
FACTORY MENU 5 CPU	PHY Test	Not active

32. UL Model Number Description

T2-2019-	A	-	B	C	-	D	E	F	G	-	H	H	-	K	K
															K = CUSTOM OPTIONS
															HH = OVERLAY OPTIONS
															AC ALARM CIRCUIT 2 (SEE "D")
															DC ALARM CIRCUIT 2 (SEE "D")
															AC ALARM CIRCUIT 1 (SEE "D")
															DC ALARM CIRCUIT 1(SEE "D")
															0 = NONE
															1 = MECHANICAL RELAY
															2 = SSR
															C=ETHERNET 0=NO 1=YES
															B=RS485 0=NO 1=YES
															A = NUMBER OF LOOPS
															1 = 1 LOOP
															2 = 2 LOOPS
MODEL NUMBER															
2019 T2 Plastic															
2022 T2 Stainless															

33. Internal Labeling Requirements

The following is a typical Model Number label installed into the enclosure:

PN: 7300-13001-07	Serial Number: 10130
UL MODEL #: T2-2019-1-10-1100-00-00	
Input Voltage: 100-277VAC 50/60HZ	
Output Rating: 30A, 100-277 VAC, 50/60Hz Resistive Load	
Temperature Range: -35°F to 104°F	
K1 Alarm Rating: 1.8A, 240 VAC, 50/60Hz : 1.8A, 80 VDC	
K3 Alarm Rating: 1.8A, 240 VAC, 50/60Hz : 1.8A, 80 VDC	
Degree Of Pollution: 4X	

<p>Use Copper Conductors Only For supply connections use No. 10 AWG or larger wires rated for at least 105°C For terminal blocks ALARM_AC, ALARM_DC, SSR_AC, SSR_DC, PRB1, PRB2, torque terminal screws to 3.1-3.5 lb-in. For terminal block TB1, torque terminal screws to 11-15 lb-in. Torque cover screws to 28-34 lb-in.</p>	<p>SSC LLC</p>  <p>THERMOSTAT E508882</p>
--	---

34. Troubleshooting

It is strongly recommended that all Technician Installers and Users read and become intimately familiar with this manual. This section may be helpful to a user or installer should questions arise:

- a) When diagnosing power questions, it may be helpful to look at the two LED's on the power board. The unit will have either 1 or 2 LED's. Units with an "R" suffix will have 1 LED (LED2), units without "R" suffix will have 2 LED's (LED2 and LED7).
 - i) LED2 on power board indicates the presence of low voltage. If this LED is not lit, it may indicate a blown fuse. Refer to technical section of manual for fuse specifications.
 - ii) LED7 on power board indicates the presence line voltage. If this LED is not lit, it may indicate loss of power to the power board. You should check AC power supply and wiring.
- b) There are two revisions of the Display Board, Revision A and B. The revision of the Display Board can be found on a label on the board. The part number is 3200-00001-01 Rev Xa where "X" indicates the revision.
 - i) Revision A boards will only operate if power is applied through circuit 1 power board
 - ii) Revision B (and higher) boards will operate when power is supplied from either or both power boards
- c) If a circuit contains "----" in only the Actual Temp field, this is most likely a defective probe assembly or miswiring of the probe connector. The technician should look at the probe and the probe parameters to diagnose the error.
- d) If a circuit contains "----" in Actual Temp., Load, and Circuit Voltage this would indicate either a loss of power to the circuit or a communication failure between the power board and the display board. The technician should check the power to the power board.
- e) If a circuit is operational and then power is lost to the power board, the display will show "----" in the Actual Temp., Load, and Circuit Voltage display fields. The power LED will flash to indicate loss of power. The output LED and the alarm LED will continue to indicate the last status of the circuit. These indicators may be useful in determining the system fault. Once the fault is corrected and power is supplied to the power board, all LED and display will operate in a normal manner.

35. Contact Information

For Sales, Service and Warranty information, please contact:

Advent Industrial Technologies

765 Vogelsong Rd
York, PA 17404

(844)923-8368
sales@advent-industrial.com
www.advent-industrial.com

36. Revision Record

Date	Revision	Changes
10/07/2018	V0.03	GFEP test is run continuously when output is on and every three minutes if output remains off for three minutes. Alarm screen added for Circuit 1 that shows all alarms and provides for a reset of a latched GFEP Alarm. Screen "timeout" changed from 30 seconds to 120 seconds. In all programming menus, the MENU key will return to the MAIN MENU. MPLABX415 10/07/2018 01:43pm 0Xe19c0b33
10/13/2018	V0.03	Added Option Kit For Line Breaking Relay to Manual. Renumbered pages. Added Alarm relay options part numbers and wiring.
11/16/2019	V0.04	Added Part number, model numbers, and How To Order.
05/10/19	V0.06	Numerous changes at customer request: Revised LED processing to use "led operation" structure EXCEPT in factory service screens. Factory service has direct manual control over LEDs to prevent operational interaction. Flash alarm LED when in alarm mode, currently it is just lit. Added option for circuit 2 to operate from circuit 1 probe Updated alarms for circuit 2 when operating from circuit a probe Updated 2 circuit alarm screen to accurately reflect status when operating from circuit 1 probe Changed "Load (%Amps) to be a factor of "on time" not "max amps". So, proportion shows 0-100%, cap start 0-100%, manual = manual% Changed "Number Of Circuits" to 7300-13001-?? in Factory Service screen. Added 4 "dashes" for 4 current configurations. Added enumerations for Baud, Parity, and Port ID Hardcoded the Factory PWD = 2112 so if corrupt, we can always get into RESET EEPROM screen Changed all screens to enumerator x/y where x=page # and y=total pages in each set up menu Added Modbus
06/19/19	V1.02	Changed defaults: 1) Change "Hysteresis" from 10 to 2 (degrees F) 2) Change "Prb Error Out %" from 50 to 100 (%)
07/13/19	V1.03	Added Bootloader Capability to allow firmware update through USB port. Changed defaults: 1) Changed default "GFEP Alarm" from "ALARM" to "TRIP". 2) Changed default "GFEP Latch" from "AUTO" to "LATCH".
9/21/19	V1.04	Updated Manual to include all changes as listed below: 1) Power LED's now indicate Low Line Voltage by blinking 2) Default screen now shows Line Voltage in place of "CAP START" 3) Grey out Prop Band and Prop Time when mode not Proportional 4) Added delay on Splash Screen to allow fields to populate at PON 5) If not OFF, GFEP now runs every 100ms 6) If not OFF, current tests run when load is ON. Running test will reset AUTO CYCLE timer. 7) Added AUTO CYCLE timer to PORT menu. AUTO CYCLE TESTS can be set to OFF, or 1 to 999 hours. 8) AUTO CYCLE tests honor CAP START setting 9) CAP START indicator added as a suffix to Control Mode field on Default Screen 10) Added GFEP outputs control for OC1 and OC2 external Relays that break both sides of line. 11) Changed fuse from 500mA to 1A to help prevent nuisance tripping. 12) Added UL instructions, labels, ratings and other items. 13) General cleanup.
01/24/2020	V1.05	ECO1308 1) Added "Ambient" sensing mode. Use Probe 1 for Process Temperature. Use Probe 2 for Alarm Temperature. 2) All Danger, Caution, and Warning markings in the manual are now included in French (to address dual language in Canada) per UL Requirement 3) Changed UL recognition marks (RU), to (c UL us) 4) General cleanup
05/30/2020	V1.05	Added 7300-13001-07 and 7300-13001-08 parts in table. Cleaned up wiring diagrams at customer request.
11/20/2020	V1.06	Added Probe Wire Length and Gauge Variables to parameter screens. Updated wiring diagrams to show specific part numbers and wiring configurations. Added OC1 to Factory screen. Other cleanup and manual update/PENDING
02/19/2021	V1.07	Updated software revision and document revision. Updated Pg 27 Probe Errors to show new feature to add "----" when circuit has an invalid probe reading. Added Circuit Configuration For 1 or 2 Circuit Display. Updated Power LED operation. Added Troubleshooting section.
5/30/2021	V1.08	Added special configuration 7300-13001-?? = 81 at customer request. Configuration 81 adds an option for probes equal to MIN 3 and MIN 4. Controller will display one loop on DEFAULT SCREEN and will use the lowest value of either 3 or four probes. This configuration requires 1 2 circuit TRACER 2. Also made minor adjustments in RS485 code to work with MSA FieldServer Gateway ProtoAir FPA-W44-XXXX
11/10/2021	V1.08 & V1.09	Added "R" suffix to part number to indicate power board configuration. P/N 7300-13001-08 contains power board containing Si8900 and 7300-13001-08R contains LSNS1 transformer.
5/13/22	V1.08/V1.10	Desensitized power loss detector software.

Date	Revision	Changes
7/29/22	V1.11	Added enhanced bootloader to allow for additional thumb drive usage. Added conditional compilers for new high-performance display.
11/24/2022	V1.12	Added TRACER 2SS product. Added Digital I/O and LOCK-OUT operation modes. Other minor enhancements.