

PULS

MiniLine

ML15.241

24V, 0.63A, SINGLE PHASE INPUT



POWER SUPPLY

- 100-240V Wide Range Input
- NEC Class 2 Compliant
- Adjustable Output Voltage
- Efficiency up to 88.4%
- Compact Design, Width only 22.5mm
- Full Output Power Between -10°C and +60°C
- Large International Approval Package
- 3 Year Warranty

1. GENERAL DESCRIPTION

A compact size, light weight, simple mounting onto the DIN-rail and the utilization of only quality components are what makes the MiniLine power supplies so easy to use and install within seconds.

A rugged electrical and mechanical design as well as a high immunity against electrical disturbances on the mains provides reliable output power. This offers superior protection for equipment which is connected to the public mains network or is exposed to a critical industrial environment.

The MiniLine series offers output voltages from 5 to 56Vdc and a power rating from 15W to 100W.

The supplementary MiniLine decoupling diode module MLY02.100 allows building of redundant systems or to protect against back-feed voltages.

ML15

Related products

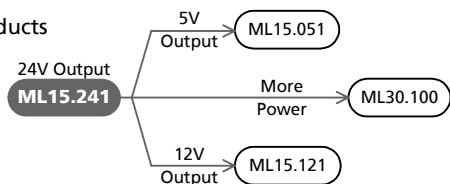

2. SHORT-FORM DATA

Output voltage	DC 24V	
Adjustment range	24-28V	
Output current	0.63-0.54A	24-28V
Output power	15W	
Output ripple	< 50mVpp	20Hz to 20MHz
Input voltage	AC 100-240V	Wide Range Input
Mains frequency	50-60Hz	±6%
AC Input current	typ. 0.28 / 0.17A	At 120 / 230Vac
Power factor	typ. 0.51 / 0.44	At 120 / 230Vac
AC Inrush current	16 / 31A	Typ. peak value at 120 / 230Vac 40°C and cold start
DC Input	85-375Vdc	
Efficiency	typ. 87.8 / 88.4%	At 120 / 230Vac
Losses	typ. 2.1 / 2.0W	At 120 / 230Vac
Temperature range	-10°C to +70°C	Operational
Derating	0.4W/°C	+60 to +70°C
Hold-up time	typ. 47 / 196ms	At 120 / 230Vac
Dimensions	22.5x75x91mm	WxHxD

3. ORDER NUMBERS

Power supply	ML15.241	Standard unit
Accessory	MLY02.100	Decoupling / Redundancy module

4. MARKINGS



PULS

MiniLine

ML15.241

24V, 0.63A, SINGLE PHASE INPUT

INDEX PAGE

1. General Description	1
2. Short-form Data	1
3. Order Numbers	1
4. Markings	1
5. AC-Input	3
6. Input Inrush Current Surge	4
7. Hold-up Time	4
8. DC-Input	5
9. Output	6
10. Efficiency and Power Losses	7
11. Functional Diagram	8
12. Reliability	8
13. Front Side and User Elements	9
14. Terminals and Wiring	9
15. EMC	10
16. Environment	11
17. Protection Features	11
18. Safety	12
19. Dielectric Strength	12

INDEX PAGE



20. Approvals	13
21. Fulfilled Standards	13
22. Used Substances	13
23. Physical Dimensions and Weight	14
24. Installation and Operation Instructions	14
25. Application Notes	15
25.1. Peak Current Capability	15
25.2. Back-feeding Loads	15
25.3. Inductive and Capacitive Loads	15
25.4. Series Operation	16
25.5. Parallel Use to Increase Output Power ..	16
25.6. Parallel Use for Redundancy	17
25.7. Charging of Batteries	17
25.8. External Input Protection	17
25.9. Functional Earth Terminal	18
25.10. Operation on Two Phases	18
25.11. Use in a Tightly Sealed Enclosure	19
25.12. Mounting Orientations	20

INTENDED USE

The power supply shall only be installed and put into operation by qualified personnel.

This power supply is designed for installation in an enclosure and is intended for the general use, such as in industrial control, office, communication, and instrumentation equipment. Do not use this device in aircraft, trains and nuclear equipment, where malfunctioning of the power supply may cause severe personal injury or threaten human life.

TERMINOLOGY AND ABBREVIATIONS

PE and  symbol	PE is the abbreviation for Protective Earth and has the same meaning as the symbol  .
Earth, Ground	This document uses the term "earth" which is the same as the U.S. term "ground".
T.b.d.	To be defined, value or description will follow later.
AC 230V	A figure displayed with the AC or DC before the value represents a nominal voltage with standard tolerances (usually ±15%) included. E.g.: DC 12V describes a 12V battery regardless whether it is charged (13.7V) or discharged (10V). As long as not otherwise stated, AC 100V and AC 230V parameters are valid at 50Hz and AC 120V parameters are valid at 60Hz mains frequency.
230Vac	A figure with the unit (Vac) at the end is a momentary figure without any additional tolerances included.

DISCLAIMER

The information presented in this document is believed to be accurate and reliable and may change without notice.

The housing is patent by PULS (US patent No US D442,923S)

No part of this document may be reproduced or utilized in any form without permission in writing from the publisher.

PULS

MiniLine

ML15.241

24V, 0.63A, SINGLE PHASE INPUT

5. AC-INPUT

AC input	nom.	AC 100-240V	Wide-range input, TN-, TT-, IT-Mains, see Fig. 5-1
AC input range		85-264Vac 264-300Vac	Continuous operation < 0.5s
Input frequency	nom.	50 – 60Hz	±6%
Turn-on voltage	typ.	59Vac	Steady-state value, see Fig. 5-1
Shut-down voltage	typ.	54Vac	Steady-state value, see Fig. 5-1

		AC 100V	AC 120V	AC 230V	
Input current (rms)	typ.	0.34A	0.28A	0.17A	At 24V, 0.63A see Fig. 5-3
Power factor *)	typ.	0.52	0.51	0.44	At 24V, 0.63A see Fig. 5-1
Crest factor **)	typ.	3.45	3.53	3.94	At 24V, 0.63A
Start-up delay	typ.	700ms	700ms	700ms	See Fig. 5-2
Rise time	typ.	20ms	20ms	24ms	At 24V, 0.63A, see Fig. 5-2
Turn-on overshoot	max.	100mV	100mV	100mV	See Fig. 5-2

*) The power factor is the ratio of the true (or real) power to the apparent power in an AC circuit.

**) The crest factor is the mathematical ratio of the peak value to RMS value of the input current waveform.

Fig. 5-1 Input voltage range

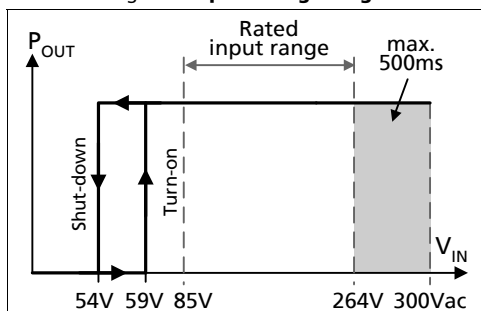

Fig. 5-2 Turn-on behavior, definitions

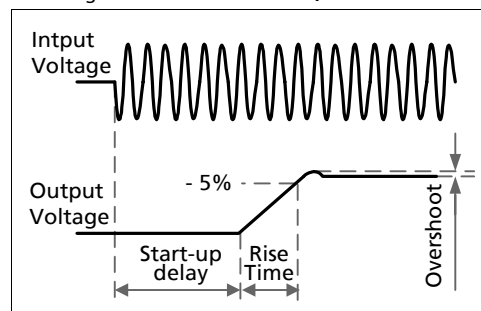

Fig. 5-3 Input current vs. output load

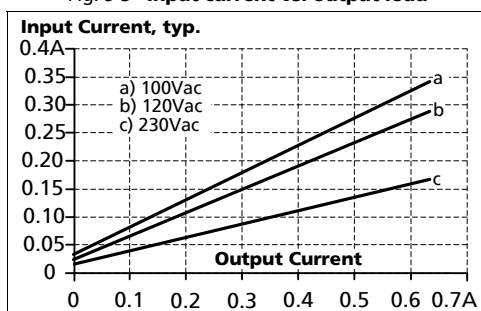
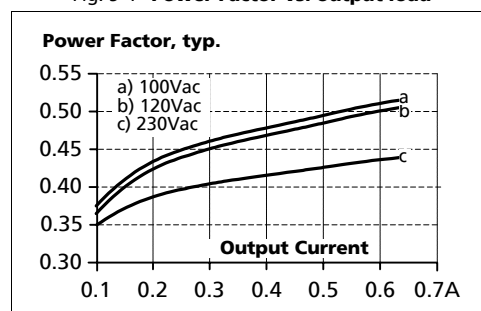

Fig. 5-4 Power Factor vs. output load



PULS

MiniLine

ML15.241

24V, 0.63A, SINGLE PHASE INPUT

6. INPUT INRUSH CURRENT SURGE

A NTC limits the input inrush current after turn-on of the input voltage. The inrush current is input voltage and ambient temperature dependent.

		AC 100V	AC 120V	AC 230V	
Inrush current	max.	13A _{peak}	16A _{peak}	31A _{peak}	40°C ambient, cold start
	typ.	11A _{peak}	13A _{peak}	26A _{peak}	40°C ambient, cold start
Inrush energy	typ.	0.1A ² s	0.1A ² s	0.4A ² s	40°C ambient, cold start

Fig. 6-1 Input inrush current, typical behavior

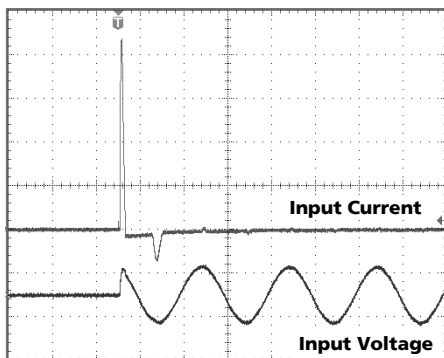

Input: 230Vac
Output: 24V, 0.63A
Ambient: 25°C
Upper curve: Input current 5A / DIV
Lower curve: Input voltage 500V / DIV
Time scale: 10ms / DIV

Fig. 6-2 Input inrush current, zoom into the first peak

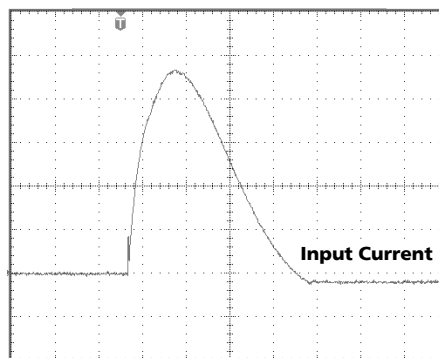

Input: 230Vac
Output: 24V, 0.63A
Ambient: 25°C
Input current curve: 5A / DIV, 500µs / DIV
I_{peak} 23A
The charging current into EMI suppression capacitors is disregarded in the first microseconds after switch-on.

7. HOLD-UP TIME

		AC 100V	AC 120V	AC 230V	
Hold-up Time	typ.	64ms	98ms	375ms	0.315A, 24V, see Fig. 7-1
	typ.	31ms	47ms	196ms	0.63A, 24V, see Fig. 7-1

Fig. 7-1 Hold-up time vs. input voltage

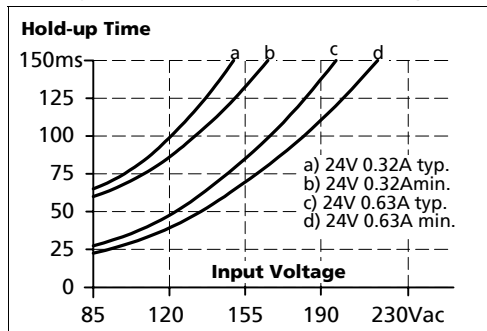
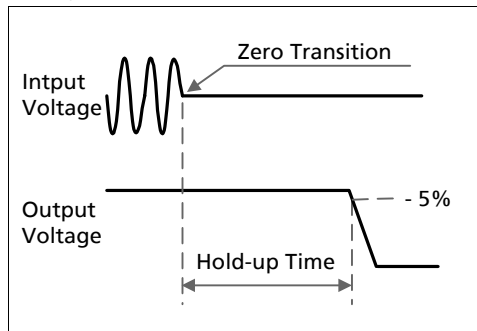

Fig. 7-2 Shut-down behavior, definitions



Note: At no load, the hold-up time can be up to several seconds. The green DC-ok lamp is also on during this time.

PULS

MiniLine

ML15.241

24V, 0.63A, SINGLE PHASE INPUT

8. DC-INPUT

DC input	nom.	DC 110-290V	-25%/+30%
DC input range	min.	85-375Vdc	Continuous operation
DC input current	typ.	0.16A / 0.057A	110Vdc / 300Vdc, at 24V and 0.63A
Turn-on voltage	typ.	80Vdc	Steady state value
Shut-down voltage	typ.	60Vdc	Steady state value

Instructions for DC use:

- Use a battery or similar DC source.
- Connect +pole to L and – pole to N.
- In case the – pole of the battery is not connected to earth, use an appropriate fuse to protect the N terminal.

Fig. 8-1 Wiring for DC Input

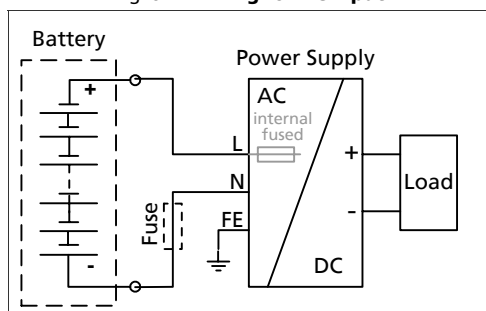

PULS

MiniLine

ML15.241

24V, 0.63A, SINGLE PHASE INPUT

9. OUTPUT

Output voltage	nom.	24V	
Adjustment range	min.	24-28V	Guaranteed
	max.	30V	At clockwise end position of potentiometer
Factory setting		24.5V	±0.2%, at full load, cold unit
Line regulation	max.	10mV	85 to 264Vac
Load regulation	max.	100mV	Static value, 0A → 0.63A → 0A
Ripple and noise voltage	max.	50mVpp	20Hz to 20MHz, 50Ohm
Output capacitance	typ.	900µF	
Output current	nom.	0.63A	At 24V, see Fig. 9-1 for typical figures
	nom.	0.54A	At 28V, see Fig. 9-1 for typical figures
Output power	nom.	15W	
Short-circuit current	min.	Hiccup mode	See Fig. 9-2
	max.	Hiccup mode	See Fig. 9-2

Fig. 9-1 Output voltage vs. output current, typ.

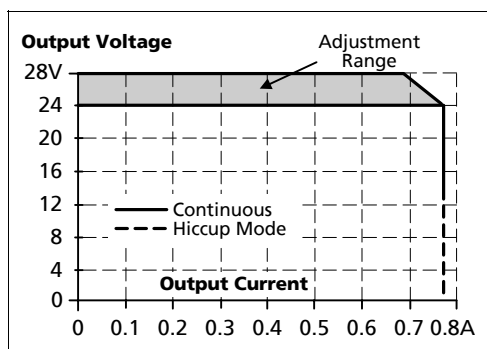
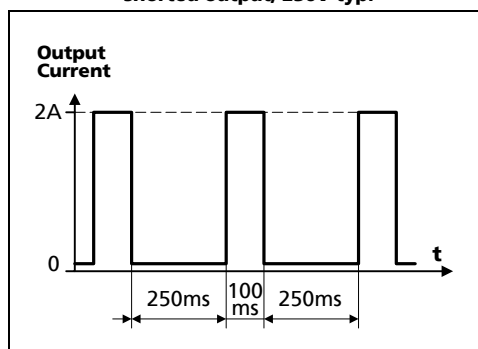

Fig. 9-2 Hiccup mode, Output current at shorted output, 230V typ.



Peak current capability (up to several ms)

The power supply can deliver a peak current which is higher than the specified short term current. This helps to start current demanding loads or to safely operate subsequent circuit breakers.

The extra current is supplied by the output capacitors inside the power supply. During this event, the capacitors will be discharged and cause a voltage dip on the output. Detailed curves can be found in chapter 25.1

Peak current voltage dips	typ.	from 24V to 15.5V	At 1.3A for 50ms, resistive load
	typ.	from 24V to 17.5V	At 3.15A for 2ms, resistive load
	typ.	from 24V to 11.5V	At 3.15A for 5ms, resistive load

PULS

MiniLine

ML15.241

24V, 0.63A, SINGLE PHASE INPUT

10. EFFICIENCY AND POWER LOSSES

		AC 100V	AC 120V	AC 230V	
Efficiency	typ.	86.8%	87.8%	88.9%	0.63A, 24V (full load)
Power losses	typ.	0.5W	0.55W	0.85W	At no load
	typ.	1.25W	1.17W	1.38W	0.315A, 24V (half load)
	typ.	2.3W	2.1W	2.0W	0.63A, 24V (full load)

Fig. 10-1 Efficiency vs. output current at 24V

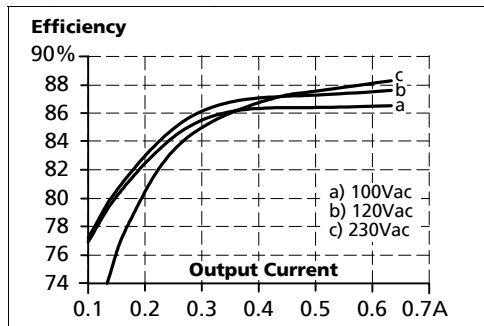

Fig. 10-2 Losses vs. output current at 24V

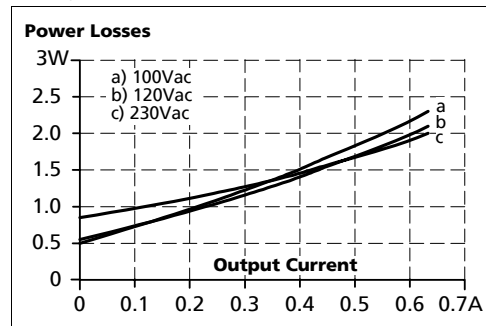

Fig. 10-3 Efficiency vs. input voltage at 24V and 0.63A

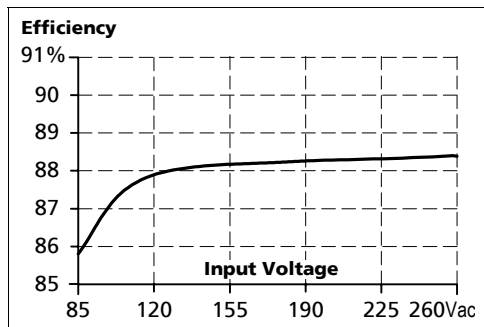
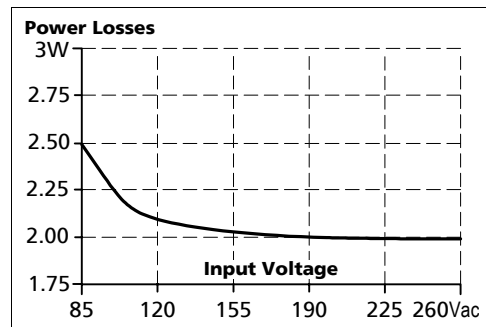

Fig. 10-4 Losses vs. input voltage at 24V and 0.63A



PULS

MiniLine

ML15.241

24V, 0.63A, SINGLE PHASE INPUT

11. FUNCTIONAL DIAGRAM

Fig. 11-1 Functional diagram

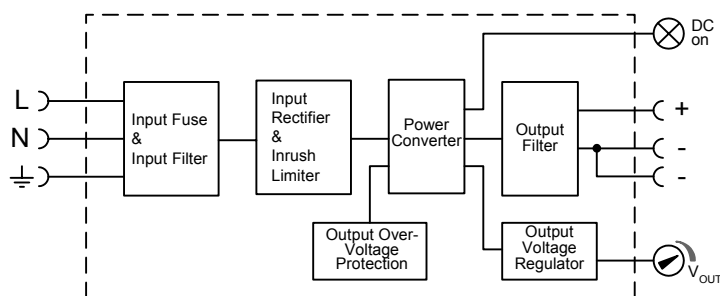

12. RELIABILITY

These units are extremely reliable and use only the highest quality materials. The number of critical components such as electrolytic capacitors has been reduced.

		AC 100V	AC 120V	AC 230V	
Lifetime expectancy	min.	197 000h	200 000h	196 000h	40°C, 24V, 0.63A
	min.	> 15 years	> 15 years	> 15 years	40°C, 24V, 0.315A
	min.	> 15 years	> 15 years	> 15 years	25°C, 24V, 0.63A
MTBF SN 29500, IEC 61709		4 016 000h	4 360 000h	4 369 000h	40°C, 24V, 0.63A
		6 586 000h	7 150 000h	7 165 000h	25°C, 24V, 0.63A
MTBF MIL HDBK 217F		1 112 000h	1 169 000h	1 095 000h	40°C, 24V, 0.63A, Ground Benign GB40
		1 490 000h	1 566 000h	1 467 000h	25°C, 24V, 0.63A, Ground Benign GB25

The **Lifetime expectancy** shown in the table indicates the operating hours (service life) and is determined by the lifetime expectancy of the built-in electrolytic capacitors.

Lifetime expectancy is specified in operational hours. Lifetime expectancy is calculated according to the capacitor's manufacturer specification. The prediction model allows a calculation of up to 15 years from date of shipment.

MTBF stands for **Mean Time Between Failure**, which is calculated according to statistical device failures, and indicates reliability of a device. It is the statistical representation of the likelihood of a unit to fail and does not necessarily represent the life of a product.

PULS

MiniLine

ML15.241

24V, 0.63A, SINGLE PHASE INPUT

13. FRONT SIDE AND USER ELEMENTS

Fig. 13-1 Front side



A Output Terminals

Screw terminals

Dual terminals for the negative pole allows an easy earthing of the output voltage

- + Positive output
- Negative (return) output

B Input Terminals

Screw terminals

- L Neutral input
- N Line (hot) input
- ⊥ EMI ground

Ground this terminal to minimize high-frequency emissions. For safety reasons, connecting to ground is not required.

C DC-ON LED (green)

On when the voltage is > 19V

D Output voltage potentiometer

Turn to set the output voltage. Factory setting is 24.5V.

14. TERMINALS AND WIRING

All terminals are easy to access when mounted on the panel. Input and output terminals are separated from each other (input below, output above) to help in error-free wiring.

Type	Screw terminals
Solid wire	0.5-6mm ²
Stranded wire	0.5-4mm ²
American wire gauge	20-10 AWG
Ferrules	Allowed, but not required
Recommended tightening torque	1Nm, 9lb.in
Screwdriver	3.5mm slotted or Pozidrive No 2
Wire stripping length	7mm / 0.275inch

Instructions:

- a) Use appropriate copper cables that are designed for an operating temperatures of 60°C (for ambient up to 45°C) and 75°C (for ambient up to 60°C), minimum.
- b) Ferrules are allowed, but not required.
- c) Follow local and national installation codes and regulations!
- d) Ensure that all strands of a stranded wire enter the terminal connection!
- e) In order to fulfill GL requirements, unused terminal spaces must be closed.

PULS

MiniLine

ML15.241

24V, 0.63A, SINGLE PHASE INPUT

15. EMC

The CE mark indicates conformance with EMC directive 89/336/EC, 93/68/EC and 2004/108/EC and the low-voltage directive (LVD) 73/23/EC, 93/68/EC, 2006/95/EC. A detailed EMC Report is available on request.

All results and investigation were performed with functional earth wire.

EMC Immunity	EN 61000-6-2, EN 61000-6-1		Generic standards	
Electrostatic discharge	EN 61000-4-2	Contact discharge	8kV	Criterion A
		Air discharge	8kV	Criterion A
Electromagnetic RF field	EN 61000-4-3	80MHz-2.7GHz	10V/m	Criterion A
Fast transients (Burst)	EN 61000-4-4	Input lines	4kV	Criterion A
		Output lines	2kV	Criterion A
Surge voltage on input	EN 61000-4-5	L → N	2kV	Criterion A
		N / L → PE	4kV	Criterion A
Surge voltage on output	EN 61000-4-5	+ → -	500V	Criterion A
		+ / - → PE	500V	Criterion A
Conducted disturbance	EN 61000-4-6	0,15-80MHz	10V	Criterion A
Mains voltage dips	EN 61000-4-11	0% of 100Vac	0Vac, 20ms	Criterion A
		40% of 100Vac	40Vac, 200ms	Criterion C
		70% of 100Vac	70Vac, 500ms	Criterion A
		0% of 200Vac	0Vac, 20ms	Criterion A
		40% of 200Vac	80Vac, 200ms	Criterion A
		70% of 200Vac	140Vac, 500ms	Criterion A
Voltage interruptions	EN 61000-4-11		0Vac, 5000ms	Criterion C
Input voltage swells	PULS internal standard		300Vac, 500ms	Criterion A
Powerful transients	VDE 0160	Over entire load range	750V, 1.3ms	Criterion A

Criteria:

A: Power supply shows normal operation behavior within the defined limits.

C: Temporary loss of function is possible. Power supply might shut-down and restarts by itself. No damages or hazards to the power supply will occur.

EMC Emission	EN 61000-6-3, EN 61000-6-4		Generic standards
Conducted emission	EN 55011, EN 55022, FCC Part 15, CISPR 11, CISPR 22 EN 55022		Class B, input lines
			Class B, output lines
Radiated emission	EN 55011, EN 55022		Class B
Harmonic input current	EN 61000-3-2		Not applicable (below 75W input power)
Voltage fluctuations, flicker	EN 61000-3-3		Fulfilled

This device complies with FCC Part 15 rules.

Operation is subjected to the following two conditions: (1) this device may not cause harmful interference, and (2) this device must accept any interference received, including interference that may cause undesired operation.

Switching frequency constant, typ. 65kHz

PULS

MiniLine

ML15.241

24V, 0.63A, SINGLE PHASE INPUT

16. ENVIRONMENT

Operational temperature	-10°C to +70°C (14°F to 158°F)	Reduce output power acc. to Fig. 16-1
Output de-rating	0.4W/°C	60-70°C (140°F to 158°F), see Fig. 16-1
Storage temperature	-40 to +85°C (-40°F to 185°F)	Storage and transportation
Humidity	5 to 95% r.H.	IEC 60068-2-30 Do not energize while condensation is present
Vibration sinusoidal	2-17.8Hz: ±1.6mm; 17.8-500Hz: 2g 2 hours / axis	IEC 60068-2-6
Shock	15g 6ms, 10g 11ms 3 bumps / direction, 18 bumps in total	IEC 60068-2-27
Altitude	0 to 6000m (0 to 20000ft)	Reduce output power or ambient temperature above 2000m sea level.
Output de-rating (for altitude)	1W/1000m or 5°C/1000m	Above 2000m (6500ft), see Fig. 16-2
Over-voltage category	III	EN 50178, IEC 62103, up to 2000m
	II	Altitudes from 2000m to 6000m
Degree of pollution	2	EN 50178, IEC 62103, non conductive

Fig. 16-1 Output power vs. ambient temperature

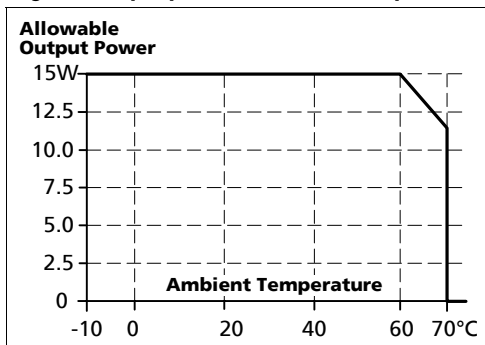
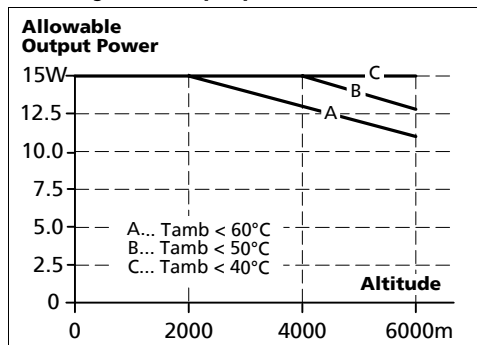

Fig. 16-2 Output power vs. altitude



The ambient temperature is defined 2cm below the unit.

17. PROTECTION FEATURES

Output protection	Electronically protected against overload, no-load and short-circuits	
Output over-voltage protection	Typ. 34V, max. 37V	In case of an internal power supply fault, a redundant circuit limits the maximum output voltage. In such a case, the output shuts down and stays down until the input voltage is turned off and on again
Output over-current protection	Electronically limited	See Fig. 9-1
Degree of protection	IP 20	EN/IEC 60529
Penetration protection	> 2.5mm in diameter	E.g. screws, small parts
Over-temperature protection	Not included	
Input transient protection	MOV	Metal Oxide Varistor
Internal input fuse	T3.15A H.B.C.	Not user replaceable

Note: In case of a over-voltage, overload, no-load or short-circuit event, an audible noise may be heard.

PULS

MiniLine

ML15.241

24V, 0.63A, SINGLE PHASE INPUT

18. SAFETY

Input / output separation	SELV PELV double or reinforced insulation	IEC/EN 60950-1 EN 60204-1, EN 50178, IEC 60364-4-41, IEC 62103
Class of protection	II	An earth connection is not required for safety reasons but recommended to achieve highest EMI immunity. See chapter 25.9 for details.
Isolation resistance	> 5MΩ	Input to output, 500Vdc
Touch current (leakage current)	typ. 0.17mA ¹⁾ / 5μA ²⁾ typ. 0.24mA ¹⁾ / 7μA ²⁾ typ. 0.40mA ¹⁾ / 8μA ²⁾ < 0.21mA ¹⁾ / 6μA ²⁾ < 0.30mA ¹⁾ / 7μA ²⁾ < 0.54mA ¹⁾ / 9μA ²⁾	100Vac, 50Hz, TN mains 120Vac, 60Hz, TN mains 230Vac, 50Hz, TN mains 110Vac, 50Hz, TN mains 132Vac, 60Hz, TN mains 264Vac, 50Hz, TN mains

- 1) Functional earth terminal connected to Protective earth
- 2) Functional earth terminal not connected

19. DIELECTRIC STRENGTH

Fig. 19-1 Dielectric strength

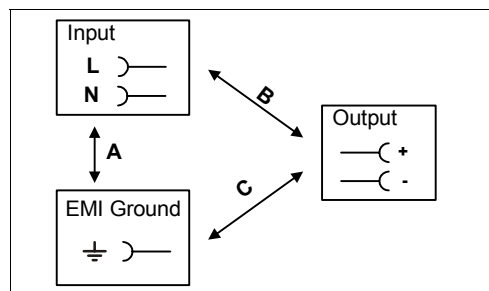

		A	B	C
Type test	60s	2500Vac	3000Vac	500Vac
Factory test	5s	2500Vac	2500Vac	500Vac
Field test	5s	2000Vac	2000Vac	500Vac

Type tests and factory tests:

Conducted by the manufacturer. Do not repeat test in field!

Rules for field test:

Use appropriate test equipment which applies the voltage with a slow ramp! Connect L and N together as well as all output poles.

The output voltage is floating and has no ohmic connection to ground.

To fulfill the PELV requirements according to EN60204-1 § 6.4.1, it is recommended that either the + pole, the - pole or any other part of the output circuit should be connected to the protective earth system. This helps to avoid situations in which a load starts unexpectedly or can not be switched off when an unnoticed earth faults occur.







PULS

MiniLine

ML15.241

24V, 0.63A, SINGLE PHASE INPUT

20. APPROVALS

IEC 60950-1		CB Scheme, Information Technology Equipment
UL 508		LISTED E198865 Industrial Control Equipment
UL 60950-1		RECOGNIZED E137006 recognized for the use in U.S.A. (UL 60950-1) and Canada (C22.2 No. 60950). Information Technology Equipment, Level 3
NEC Class 2		According to NEC (National Electrical Code) Article 725-41 (4). Listed as Limited Power Source (LPS) in the UL 60950-1 UL report.
Class I Div 2		RECOGNIZED E246877 Hazardous Location Class I Div 2 T4 Groups A,B,C and D ANSI/ISA-12.12.01 (UL 1604)
The unit is suitable for use in Class I Division 2 Groups A, B, C, D locations. Substitution of components may impair suitability for Class I Division 2 environment. Do not disconnect equipment unless power has been switched off. Wiring must be in accordance with Class I, Division 2 wiring methods of the National Electrical Code, NFPA 70, and in accordance with other local or national codes.		
CSA		CSA approval for Canada CAN/CSA C22.2 No 107-1; CAN/ CSA 60950-1-03; UL60950-1
Marine		GL (Germanischer Lloyd) classified and ABS (American Bureau for Shipping) PDA for marine and offshore applications. Environmental category: C, EMC2

21. FULFILLED STANDARDS

EN 61558-2-17	Safety of Power Transformers
EN/IEC 60204-1	Safety of Electrical Equipment of Machines
EN/IEC 61131-2	Programmable Controllers
EN 50178, IEC 62103	Electronic Equipment in Power Installations

22. USED SUBSTANCES

Electrolytic capacitors included in this unit do not use electrolytes such as Quaternary Ammonium Salt Systems.

The unit conforms to the RoHS directive 2002/96/EC

Plastic housings and other molded plastic materials are free of halogens, wires and cables are not PVC insulated.

The materials used in our production process do not include the following toxic chemicals:
Polychlorinated Biphenyl (PCB), Pentachlorophenol (PCP), Polychlorinated naphthalene (PCN), Polybrominated Biphenyl (PBB), Polybrominated Biphenyl Oxide (PBO), Polybrominated Diphenyl Ether (PBDE), Polychlorinated Diphenyl Ether (PCDE), Polybrominated Diphenyl Oxide (PBDO), Cadmium, Asbestos, Mercury, Silica

PULS

MiniLine

ML15.241

24V, 0.63A, SINGLE PHASE INPUT

23. PHYSICAL DIMENSIONS AND WEIGHT

Weight	130g / 0.29lb
DIN-Rail	Use 35mm DIN-rails according to EN 60715 or EN 50022 with a height of 7.5 or 15mm. The DIN-rail height must be added to the depth (91mm) to calculate the total required installation depth.
Electronic files with mechanical data can be downloaded at www.pulspower.com	

Fig. 23-1 Front view

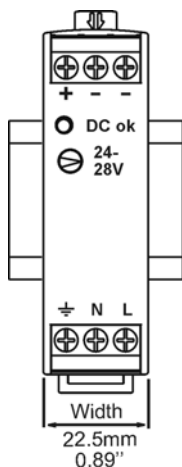
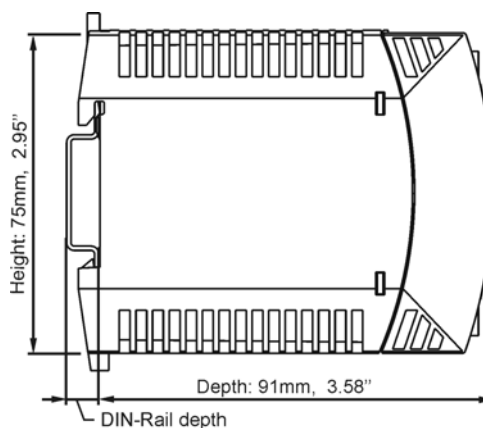

Fig. 23-2 Side view



24. INSTALLATION AND OPERATION INSTRUCTIONS

Mounting:

Output terminal must be located on top and input terminal on the bottom. For other orientations see chapter 25.12. An appropriate electrical and fire end-product enclosure should be considered in the end use application.

Cooling:

Convection cooled, no forced cooling required. Do not cover ventilation grill (e.g. cable conduits) by more than 30%!

Installation clearances:

25mm on top and bottom.

Risk of electrical shock, fire, personal injury or death!

Turn power off before working on the power supply. Protect against inadvertent re-powering.

Make sure the wiring is correct by following all local and national codes.

Do not open, modify or repair the unit.

Use caution to prevent any foreign objects from entering into the housing.

Do not use in wet locations or in areas where moisture or condensation can be expected.

Service parts:

The unit does not contain any service parts. The tripping of an internal fuse is caused by an internal fault. If damage or malfunctioning should occur during operation, immediately turn power off and send unit to the factory for inspection!

25. APPLICATION NOTES

25.1. PEAK CURRENT CAPABILITY

Solenoids, contactors and pneumatic modules often have a steady state (sealed) coil and a pick-up coil. The inrush current demand of the pick-up coil is several times higher than the steady state current and usually exceeds the nominal output current. The same situation applies, when starting a capacitive load.

Branch circuits are often protected with circuit breakers or fuses. In case of a short or an overload in the branch circuit, the protective device (fuse, circuit breaker) needs a certain amount of over-current to trip or to blow. The peak current capability ensures the safe operation of subsequent circuit breakers.

Assuming the input voltage is turned on before such an event, the built-in large sized output capacitors inside the power supply can deliver extra current. Discharging this capacitor causes a voltage dip on the output. The following two examples show typical voltage dips:

Fig. 25-1 Peak load 1.3A for 50ms, typ.

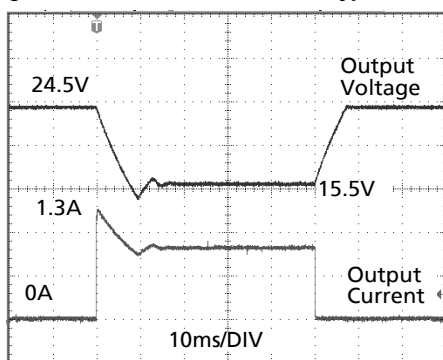

Peak load 1.3A (resistive) for 50ms
Output voltage dips from 24V to 15.5V.

Fig. 25-2 Peak load 3.15A for 5ms, typ.

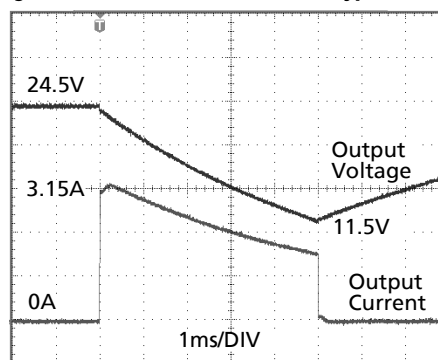

Peak load 3.15A (resistive) for 5ms
Output voltage dips from 24V to 11.5V.

25.2. BACK-FEEDING LOADS

Loads such as decelerating motors and inductors can feed voltage back to the power supply. This feature is also called return voltage immunity or resistance against Back- E.M.F. (Electro Magnetic Force).

The maximum allowed feed back voltage is 35Vdc. The absorbing energy can be calculated according to the built-in large sized output capacitor which is specified in chapter 9.

This power supply is resistant and does not show malfunctioning when a load feeds back voltage to the power supply. It does not matter, whether the power supply is on or off. However, please note that the output voltage can dip to zero for approximately 200ms if the back-feed voltage is removed.

25.3. INDUCTIVE AND CAPACITIVE LOADS

The unit is designed to supply unlimited inductive loads. The max. capacitive load depend on the steady state output current. At 0.6A output current, the output capacity should not be larger than 660µF at 0.3A output not larger than 2500µF. In case of larger capacitors, the unit can show start-up attempts or start-up problems.

25.4. SERIES OPERATION

The power supply can be put in series to increase the output voltage.

Fig. 25-3 Schematic for series operation

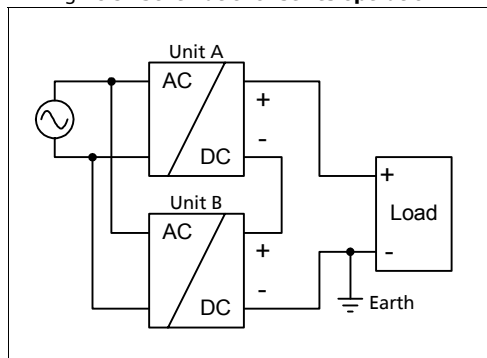

Instructions for use in series:

- It is possible to connect as many units in series as needed, providing the sum of the output voltage does not exceed 150Vdc.
- Voltages with a potential above 60Vdc are not SELV any more and can be dangerous. Such voltages must be installed with a protection against touching.
- For serial operation use power supplies of the same type.
- Earthing of the output is required when the sum of the output voltage is above 60Vdc.

Note: Avoid return voltage (e.g. from a decelerating motor or battery) which is applied to the output terminals.

25.5. PARALLEL USE TO INCREASE OUTPUT POWER

Several power supplies can be paralleled to increase the output power. The ML15.241 has no feature included which balances the load current between the power supplies. Usually the power supply with the higher adjusted output voltage draws current until it goes into current limitation. This means no harm to this power supply as long as the ambient temperature stays below 50°C.

Fig. 25-4 Schematic for parallel operation

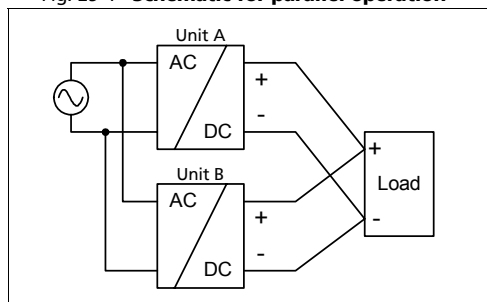

Instructions for parallel use:

- Use only power supplies from the same series (ML-Series).
- Adjust the output voltages of all power supplies to approximately the same value ($\pm 200\text{mV}$).
- A fuse (or diode) on the output is only required if more than three units are connected in parallel.
- Ensure that the ambient temperature of the power supply does not exceed 50°C.

PULS

MiniLine

ML15.241

24V, 0.63A, SINGLE PHASE INPUT

25.6. PARALLEL USE FOR REDUNDANCY

Power supplies can be paralleled for redundancy to gain a higher system reliability. Redundant systems require a certain amount of extra power to support the load in case one power supply unit fails. The simplest way is to put two MiniLine power supplies in parallel. This is called a 1+1 redundancy. In case one power supply unit fails, the other one is automatically able to support the load current without any interruption. Redundant systems for a higher power demand are usually built in a N+1 method. E.g. Five power supplies, each rated for 0.63A are paralleled to build a 2.5A redundant system. If one unit fails, the 2.5A can still be drawn.

Please note: This simple way to build a redundant system has two major disadvantages:

- The faulty power supply can not be recognized. The green LED will still be on since it is reverse-powered from the other power supply.
- It does not cover failures such as an internal short circuit in the secondary side of the power supply. In such a situation the defective unit becomes a load for the other power supplies and the output voltage can not be maintained any more.

This above conditions can be avoided by utilizing decoupling diodes which are included in the decoupling module MLY02.100.

Other recommendations for building redundant power systems:

- a) Use separate input fuses for each power supply.
- b) When possible, connect each power supply to different phases of the mains network.

25.7. CHARGING OF BATTERIES

The power supply can be used for float-charging of lead-acid or maintenance free 24V VRLA batteries.

Instructions for charging batteries:

- a) Ensure that the ambient temperature of the power supply does not exceed 50°C.
- b) Set the output voltage on a disconnected load, very precisely to the end-of-charge voltage according to the expected battery temperature.

End-of-charge voltage	27.8V	27.5V	27.15V	26.8V
Battery temperature	10°C	20°C	30°C	40°C

- c) Use a 1A or 2A circuit breaker (or blocking diode) between the power supply and the battery.
- d) Ensure that the output current of the power supply is below the allowed charging current of the battery.
- e) Use only matched batteries when putting 12V types in series.
- f) The return current to the power supply is typ. 15mA at 25Vdc when the power supply is switched off (except in case a blocking diode is utilized).

25.8. EXTERNAL INPUT PROTECTION

The unit is tested and approved for branch circuits up to 15A (UL) or 16A (IEC). External protection is only required if the supplying branch has an ampacity greater than this. In some countries local regulations might apply so check local codes and requirements.

If an external protective device is utilized, a minimum value is required to avoid undesired tripping of the fuse.

	B-Characteristic		C-Characteristic	
Ampacity	max.	15A (UL), 16A (IEC)	max.	15A (UL), 16A (IEC)
	min.	10A	min.	6A

PULS

MiniLine

ML15.241

24V, 0.63A, SINGLE PHASE INPUT

25.9. FUNCTIONAL EARTH TERMINAL

From a safety standpoint, the unit is designed according to the requirements for Protection Class 2 which does not require an earth connection. However, connecting the Functional Earth terminal can be beneficial to gain a high EMI immunity.

Symmetrical spikes or fast transients on the input side can be conducted directly to earth by the built-in filter capacitors. The magnitude of such spikes or fast transients on the output side caused by the input are much smaller compared to not connecting the FE terminal to ground.

Therefore, we recommend to connect the FE terminal to ground.

Fig. 25-5 Functional earth terminal connected to earth

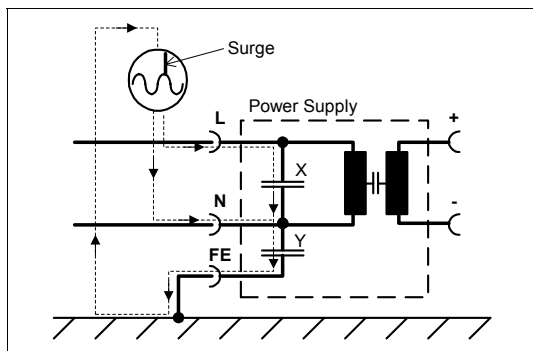
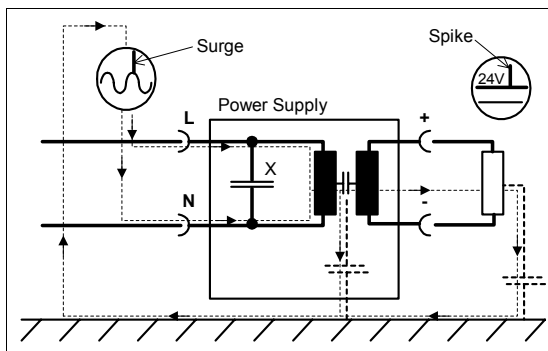

Fig. 25-6 Functional earth terminal not connected to earth



25.10. OPERATION ON TWO PHASES

The power supply can be used on two phases of a three-phase-system

Instructions for two phase operation:

- A phase to phase connection is allowed as long as the supplying voltage is below $240V^{+10\%}$.
- Use a fuse or a circuit breaker to protect the N input. The N input is internally not protected and is in this case connected to a hot wire. Appropriate fuses or circuit breakers are specified in section 25.7 "External Input Protection".

Fig. 25-7 Schematic for two phase operation

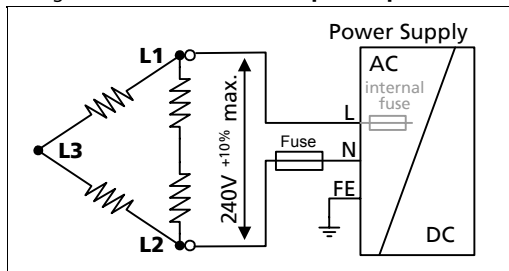

PULS

MiniLine

ML15.241

24V, 0.63A, SINGLE PHASE INPUT

25.11. USE IN A TIGHTLY SEALED ENCLOSURE

When the power supply is installed in a tightly sealed enclosure, the temperature inside the enclosure will be higher than the outside. The inside temperature defines the ambient temperature for the power supply.

Results from such an installation:

Power supply is placed in the middle of the box, no other heat producing equipment inside the box

Enclosure: Rittal Type IP66 Box PK 9510 100, plastic, 130x130x75mm

Input: 230Vac

Load: 24V, 0.63A; load is placed outside the box

Temperature inside the box: 35.9°C (in the middle of the right side of the power supply with a distance of 1cm)

Temperature outside the box: 27.9°C

Temperature rise: 8K

Load: 24V, 0.5A; (=80%) load is placed outside the box

Temperature inside the box: 33.5°C (in the middle of the right side of the power supply with a distance of 1cm)

Temperature outside the box: 27.4°C

Temperature rise: 6.1K

PULS

ML15.241

MiniLine

24V, 0.63A, SINGLE PHASE INPUT

25.12. MOUNTING ORIENTATIONS

Mounting orientations other than input terminals on the bottom and output on the top requires a reduction in continuous output power or a limitation in the maximum allowed ambient temperature. The amount of reduction influences the lifetime expectancy of the power supply. Therefore, two different derating curves for continuous operation can be found below:

Curve A1 Recommended output power.

Curve A2 Max allowed output power (results approx. in half the lifetime expectancy of A1).

Fig. 25-8

Mounting Orientation A
Standard Orientation

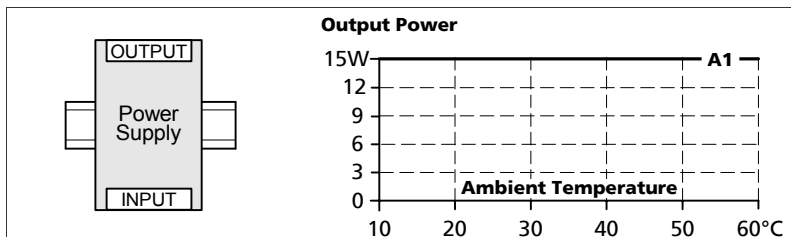

Fig. 25-9

Mounting Orientation B
(Upside down)

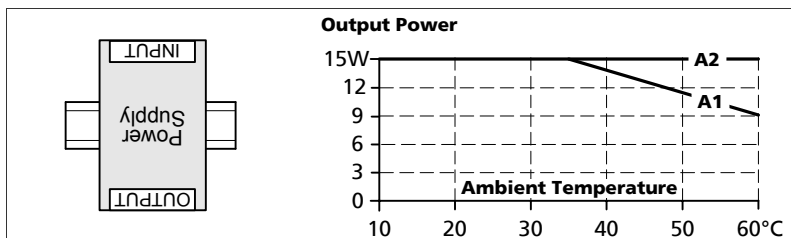

Fig. 25-10

Mounting Orientation C
(Table-top mounting)

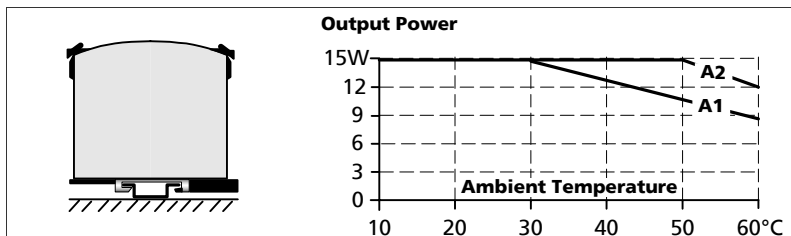

Fig. 25-11

Mounting Orientation D
(Horizontal cw)

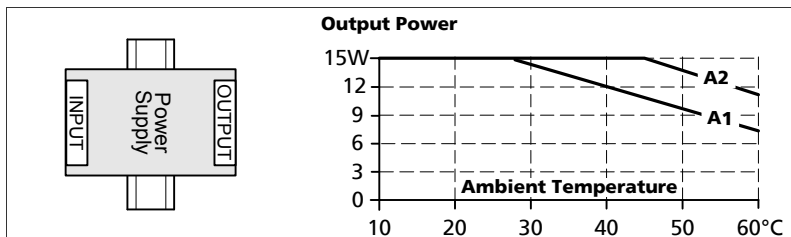

Fig. 25-12

Mounting Orientation E
(Horizontal ccw)

