



M DRIVE 34™

MOTOR+DRIVER

AC Plus

MICROSTEPPING

FEATURES

- Highly Integrated Microstepping Driver and NEMA 34 High Torque 1.8° Brushless Step Motor
- Advanced 2nd Generation Current Control for Exceptional Performance and Smoothness
- Single Supply: 120 or 240 VAC
- Cost Effective
- Extremely Compact
- High Positioning Accuracy
- No Tuning Required
- Stable at Low Speeds
- No Dithering at Zero Speed
- High Starting Torque
- Allows for Greater Inertia Mismatch
- Built-in Regeneration Circuitry
- 20 Microstep Resolutions up to 51,200 Steps Per Rev Including: Degrees, Metric, Arc Minutes
- Optically Isolated Logic Inputs will Accept +5 to +24 VDC Signals, Sourcing or Sinking
- Automatic Current Reduction
- Configurable:
 - Motor Run/Hold Current
 - Motor Direction vs. Direction Input
 - Microstep Resolution
 - Clock Type: Step and Direction, Quadrature, Step Up and Step Down
 - Programmable Digital Filtering for Clock and Direction Inputs
- Available Options:
 - Long Life Linear Actuators**
 - Internal Differential Optical Encoder
 - Integrated Planetary Gearbox
 - Control Knob for Manual Positioning
 - IP65 Sealed Configuration
 - Linear Slide
- 3 Rotary Motor Lengths Available
- Setup Parameters May Be Switched On-The-Fly
- Standard Industrial Connectors:
 - Circular 19-Pin M23
 - Circular 3-Pin Euro AC
- Graphical User Interface (GUI) for Quick and Easy Parameter Setup

DESCRIPTION

The **MDrive34AC Plus Microstepping** high torque integrated motor and step and direction driver is ideal for designers who want the simplicity of a motor with on-board electronics. The integrated electronics of the MDrive34AC Plus eliminate the need to run motor cabling through the machine, reducing the potential for problems due to electrical noise.

The unsurpassed smoothness and performance delivered by the MDrive34AC Plus Microstepping are achieved through IMS's advanced 2nd generation current control. By applying innovative techniques to control current flow through the motor, resonance is significantly dampened over the entire speed range and audible noise is reduced.

The MDrive34AC Plus accepts a broad input voltage range from 95 to 264 VAC, delivering enhanced performance and speed. Oversized input capacitors are used to minimize power line surges, reducing problems that can occur with long runs and multiple drive systems. An extended operating range of -40° to +75°C provides long life, trouble free service in demanding environments.

The MDrive34AC Plus uses a NEMA 34 frame size high torque brushless step motor combined with a microstepping driver, and accepts up to 20 resolution settings from full to 256 microsteps per full step, including: degrees, metric and arc minutes. These settings may be changed on-the-fly or downloaded and stored in nonvolatile memory with the use of a simple GUI which is provided. This eliminates the need for external switches or resistors. Parameters are changed via an SPI port.

For use in environments where exposure to chemical, dust and liquids may occur, a sealed MDrive34AC Plus Microstepping

unit with circular connectors meets IP65 specifications.**

The versatile MDrive34AC Plus Microstepping is available in multiple configurations to fit various system needs. Three rotary motor lengths are available and may include an internal optical encoder, a control knob for manual positioning, an integrated planetary gearbox or a linear slide. Long life Acme screw linear actuator versions are also available.**

Interface connections are accomplished using standard industrial circular connectors. And connectivity has never been easier with options ranging from **all-inclusive QuickStart Kits** to **individual interfacing cables**. See pg 4.

The MDrive34AC Plus is a compact, powerful and cost effective solution that will reduce system cost, design and assembly time for a large range of brushless step motor applications.

CONFIGURING

The IMS Motor Interface software is an easy to install and use GUI for configuring the MDrive34AC Plus from a computer's USB port. GUI access is via the IMS SPI Motor Interface available at www.imshome.com.

The IMS SPI Motor Interface features:

- Easy installation.
- Automatic detection of MDrive version and communication configuration.
- Will not set out-of-range values.
- Tool-tips display valid range setting for each option.
- Simple screen interfaces.

**Consult Factory for Availability.

MDrive34AC Plus MICROSTEPPING

STANDARD SPECIFICATIONS

INPUT VOLTAGE	Range	120 V MDrive – 95 to 132 VAC @ 50/60 Hz 240 V MDrive – 95 to 264 VAC @ 50/60 Hz		
ISOLATED INPUT	Step Clock, Direction and Enable			
	Voltage Range	+5 to +24 VDC Sourcing or Sinking		
MOTION	Digital Filter Range	50 nS to 12.9 μS (10 MHz to 38.8 kHz)		
	Clock Types	Step/Direction, Quadrature, Step Up/Step Down		
	Step Frequency (Max)	2 MHz		
	Resolution	Number of Settings	20	
		Steps Per Revolution	200, 400, 800, 1000, 1600, 2000, 3200, 5000, 6400, 10000, 12800, 20000, 25000, 25600, 40000, 50000, 51200, 36000 (0.01 deg/μstep), 21600 (1 arc minute/μstep), 25400 (0.001mm/μstep)	
TEMP OUTPUT WARNING	Open-Drain Type	+5 to +24 VDC	50 mA Current	
THERMAL	Operating Temperature	Heat Sink	-40° to +75°C (non-condensing)	
		Motor	-40° to +90°C (non-condensing)	
PROTECTION	Type	Thermal, Internal Fuse †		

† Designed for line-neutral systems.

SETUP PARAMETERS

	Function	Range	Units	Default
MHC	Motor Hold Current	0 to 100	percent	5
MRC	Motor Run Current	1 to 100	percent	25
MSEL	Microstep Resolution	1, 2, 4, 5, 8, 10, 16, 25, 32, 50, 64, 100, 108, 125, 127, 128, 180, 200, 250, 256	μsteps per full step	256
DIR	Motor Direction Override	0/1	—	CW
HCDT	Hold Current Delay Time	0 or 2–65535	mSec	500
CLK TYPE	Clock Type	Step/Dir, Quadrature, Up/Down	—	Step/Dir
CLK IOF	Clock and Direction Filter	50 nS to 12.9 μS (10 MHz to 38.8 kHz)	nS (MHz)	200 nS (2.5 MHz)
USER ID	User ID	Customizable	1–3 characters	IMS
EN ACT	Enable Active	High/Low	—	High
WARN TEMP	Over Temperature Warning	0 to 125°C	°C	80°C

All parameters are set using the supplied IMS SPI Motor Interface GUI and may be changed on-the-fly. An optional Communication Converter is recommended with first orders.

MOTOR SPECIFICATIONS

	Holding Torque	Detent Torque	Rotor Inertia	Weight (Motor+Driver)
SINGLE LENGTH	330 oz-in / 233 N-cm	10.9 oz-in / 7.7 N-cm	0.01416 oz-in-sec ² / 1.0 kg-cm ²	6.4 lb / 2.9 kg
DOUBLE LENGTH	500 oz-in / 353 N-cm	14.16 oz-in / 10.0 N-cm	0.02266 oz-in-sec ² / 1.6 kg-cm ²	7.7 lb / 3.5 kg
TRIPLE LENGTH	750 oz-in / 529 N-cm	19.83 oz-in / 14.0 N-cm	0.04815 oz-in-sec ² / 3.4 kg-cm ²	11.0 lb / 5.0 kg

ENCODER SPECIFICATIONS

INTERNAL DIFFERENTIAL OPTICAL ENCODER	Pin Assignments		Line Count	Part Number
	19-Pin M23 Connector	Function		
	Pin 3	Index +	100	EA
	Pin 4	Channel B +	200	EB
	Pin 5	Channel B -	250	EC
	Pin 7	Channel A +	256	EW
	Pin 14	Index -	400	ED
	Pin 15	Channel A -	500	EH
		512	EX	
		1000	EJ	
		1024	EY	

SPEED-TORQUE

MDrive34AC – 120VAC

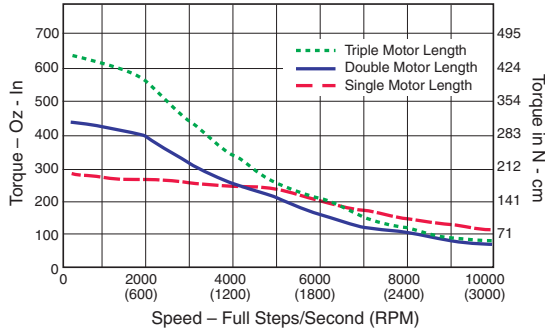

MDrive34AC – 240VAC

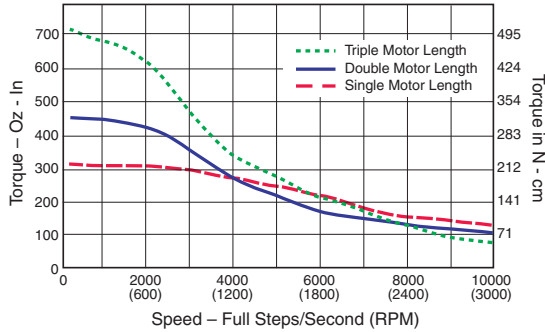

PIN ASSIGNMENTS

P1: I/O & COMM (SPI) CONNECTOR

M23 Circular (Male)	Function	Function with Encoder
Pin 1	Optocoupler Reference	Optocoupler Reference
Pin 2	Enable Input	Enable Input
Pin 3	No Connect	Index +
Pin 4	No Connect	Channel B +
Pin 5	No Connect	Channel B -
Pin 6	No Connect	No Connect
Pin 7	No Connect	Channel A +
Pin 8	SPI Master Out - Slave In	SPI Master Out - Slave In
Pin 9	SPI Chip Select	SPI Chip Select
Pin 10	+5 VDC Output	+5 VDC Output
Pin 11	Communications Ground	Communications Ground
Pin 12	Shell Connect	Shell Connect
Pin 13	CW/CCW Direction Input	CW/CCW Direction Input
Pin 14	No Connect	Index -
Pin 15	No Connect	Channel A -
Pin 16	SPI Clock	SPI Clock
Pin 17	SPI Master In - Slave Out	SPI Master In - Slave Out
Pin 18	Step Clock Input	Step Clock Input
Pin 19	Temp Output Warning	Temp Output Warning

P3: POWER CONNECTOR

Euro AC (Male)	Function
Pin 1	Chassis Ground
Pin 2	AC Power Line
Pin 3	AC Power Neutral

MECHANICAL SPECIFICATIONS

Dimensions in Inches (mm)

MDrive34AC Plus

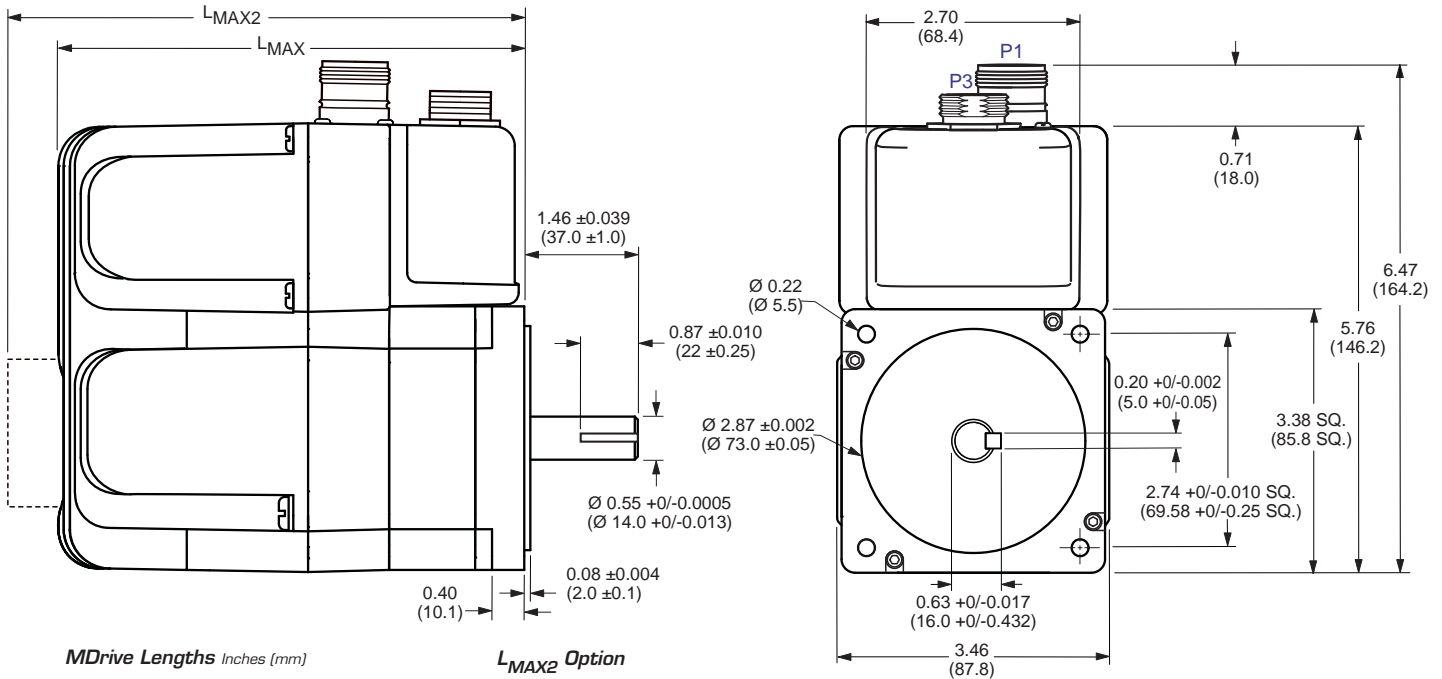

MDrive Lengths Inches (mm)

Motor Length	LMAX	LMAX2
	SINGLE SHAFT, ENCODER or LINEAR ACTUATOR VERSION	CONTROL KNOB VERSION
Single	6.1 (155.0)	7.1 (180.4)
Double	6.9 (174.3)	7.9 (199.7)
Triple	8.4 (214.3)	9.4 (239.7)

L_{MAX2} Option

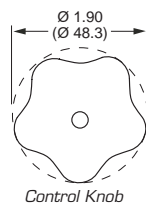

Connectors

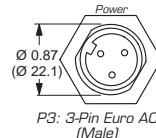
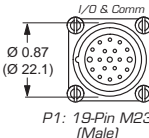

ORDER INFORMATION — MDrive34AC Plus Microstepping

CONNECTIVITY

QuickStart Kit
For rapid design verification, all-inclusive QuickStart Kits have communication converter, prototype development cable(s), instructions and CD for MDrivePlus initial functional setup and system testing.

Communication Converter
Electrically isolated, in-line converter pre-wired with mating connector to conveniently set/program communication parameters for a single MDrivePlus via a PC's USB port. Length 12.0" (3.6m).
Mates to connector:
19-Pin M23MD-CC301-001

Prototype Development Cables
Speed test/development with pre-wired mating connectors that have flying leads other end. Single-ended cordsets are PVC jacketed with foil shield and unconnected drain wire. Length 13.0' (4.0m).
Mates to connector:
19-Pin M23
Straight TerminationMD-CS100-000
Right Angle TerminationMD-CS101-000
3-Pin Euro AC
Straight TerminationMD-CS200-000
Right Angle TerminationMD-CS201-000

**Consult Factory for Availability.
‡ Not Available with Sealed -65 Versions.

Connectivity details: www.imshome.com/cables_cordsets.html

OPTIONS

Linear Actuator**
The MDrive34AC Plus is offered with numerous linear actuator styles and options to satisfy a broad range of linear motion applications. Contact the factory for details or see: www.imshome.com/mdriveplus_linear_actuator.html

Internal Encoder
Internal differential optical encoders are offered factory-mounted with the MDrive34AC Plus Microstepping. Refer to the Encoder Specifications section for available line counts. All encoders come with an index mark.

Control Knob‡
For manual shaft positioning, a factory-mounted rear control knob is available.

Planetary Gearbox
Efficient, low maintenance planetary gearboxes are offered factory-mounted. Refer to details and part numbers on the back cover.

Linear Slide
Integrated linear slides are available factory installed for precision linear movement. Screw leads are 0.1", 0.2", 0.5" or 1.0" of travel per rev. Slides are 12.0" (30.5cm) to 42.0" (106.7cm) long. Contact factory for custom lengths. Refer to separate datasheet or web site for complete details.

PART NUMBERING

Plus
base version

Plus-65
IP65 sealed

K MDM MSZ34 - **OPTION**

QuickStart Kit
details above

MDrive Version
1 = Plus
2 = Plus-65 (sealed)

Input Voltage
1 = 120 Volt
2 = 240 Volt

Motor
A = Single Length & Linear Actuator**
B = Double Length
C = Triple Length

P3: Power, 3-Pin Euro AC Connector

P1: I/O & Communications, 19-Pin M23 Circular Connector

Example #1: Part Number **MDM1MSZ34B2** is an MDrive34AC Plus Microstepping with 19-pin M23 circular I/O & SPI communications interface, NEMA 34 double length motor and 240 input voltage.

**Consult Factory for Availability.

OPTIONS

Linear Actuator** -L
For complete product specifications, see: www.imshome.com/mdriveplus_linear_actuator.html

Internal Encoder -E
Refer to encoder specifications section for line counts and part numbers.
Example: **MDM1MSZ34B2-EX** adds an internal 512-line differential optical encoder with index mark to example #1.

Control Knob -N
Example: **MDM1MSZ34B2-N** adds a rear control knob to example #1. *Not available with sealed -65 versions.*

Planetary Gearbox -G -F
Refer to gearbox page for complete table of ratios and part numbers.
Optional NEMA Flange
Example: **MDM1MSZ34B2-G1A2** adds a 1-stage planetary gearbox with 5.18:1 ratio to example #1. Add -F for optional NEMA flange.

Linear Slide -R
Screw Lead (inches/rev)
A = 0.10" (2.54mm)
B = 0.20" (5.08mm)
C = 0.50" (12.7mm)
D = 1.00" (25.4mm)
Standard Screw Lengths
12", 18", 24", 36" or 42"
For Custom Lengths, Consult Factory
Example: **MDM1MSZ34B2-RA12** adds a Linear Slide with 0.10" screw lead, 12" long to example #1.

MDRIVE34AC PLUS WITH PLANETARY GEARBOX

The MDrive34AC Plus is available with a Planetary Gearbox option developed to increase torque at lower speeds, enable better inertia matching and produce finer positional resolutions. These efficient, low maintenance Planetary Gearbox come fully assembled with the MDrive and are offered in a large number of reduction ratios in 1-, 2- and 3-stage configurations. An optional NEMA Output Flange allows mounting the Planetary Gearbox to the load using a standard NEMA bolt circle. Planetary Gearbox may be combined with other MDrive34AC Plus options, however are unavailable with Linear Actuators.

Planetary Gearbox Parameters

	Permitted Output Torque (oz-in./Nm)	Gearbox Efficiency	Maximum Backlash	Output Side with Ball Bearing			
				Maximum Load (lb-force./N)		Weight (oz./g)	
				Radial	Axial	Gearbox	with Flange
1-STAGE	2832/20.0	0.80	1.0°	90/400	18/80	64.4/1827	66.7/1890
2-STAGE	8496/60.0	0.75	1.5°	135/600	27/120	89.5/2538	92.6/2625
3-STAGE	16992/120.0	0.70	2.0°	225/1000	45/200	114.6/3248	118.5/3360

Ratios and Part Numbers

Planetary Gearbox	Ratio (Rounded)	Part Number**
1-Stage	3.71:1	G1A1
1-Stage	5.18:1	G1A2
1-Stage	6.75:1	G1A3
2-Stage	13.73:1	G1A4
2-Stage	15.88:1	G1A5
2-Stage	18.37:1	G1A6
2-Stage	19.20:1	G1A7
2-Stage	22.21:1	G1A8
2-Stage	25.01:1	G1A9
2-Stage	26.85:1	G1B1
2-Stage	28.93:1	G1B2
2-Stage	34.98:1	G1B3
2-Stage	45.56:1	G1B4
3-Stage	50.89:1	G1B5
3-Stage	58.86:1	G1B6
3-Stage	68.07:1	G1B7
3-Stage	71.16:1	G1B8
3-Stage	78.72:1	G1B9
3-Stage	92.70:1	G1C1
3-Stage	95.18:1	G1C2
3-Stage	99.51:1	G1C3
3-Stage	107.21:1	G1C4
3-Stage	115.08:1	G1C5
3-Stage	123.98:1	G1C6
3-Stage	129.62:1	G1C7
3-Stage	139.14:1	G1C8
3-Stage	149.90:1	G1C9
3-Stage	168.85:1	G1D1
3-Stage	181.25:1	G1D2
3-Stage	195.27:1	G1D3
3-Stage	236.10:1	G1D4
3-Stage	307.55:1	G1D5

Planetary Gearbox for MDrive34AC Plus

Dimensions in Inches (mm)

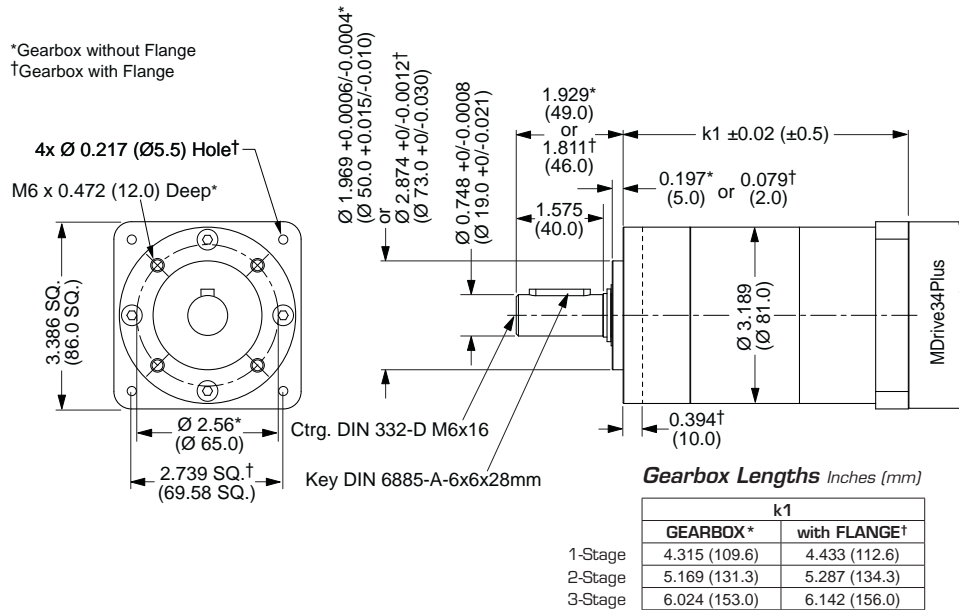

**Include optional planetary gearbox by adding -G plus 3 characters to the end of an MDrive part number.

U.S.A. SALES OFFICES

Eastern Region

Tel. 862 208-9742 - Fax 973 661-1275
e-mail: jroake@imshome.com

Central Region

Tel. 260 402-6016 - Fax 419 858-0375
e-mail: dwaksman@imshome.com

Western Region

Tel. 602 578-7201
e-mail: dweisenberger@imshome.com

IMS ASIA PACIFIC OFFICE

30 Raffles Pl., 23-00 Caltex House, Singapore 048622
Tel. +65/6233/6846 - Fax +65/6233/5044
e-mail: wlee@imshome.com

IMS EUROPEAN SALES MANAGEMENT

4 Quai Des Etroits
69005 Lyon, France
Tel. +33/4 7256 5113 - Fax +33/4 7838 1537
e-mail: bmartinez@imshome.com

IMS UK Ltd.

Sanderson Centre, 15 Lees Lane
Gosport, Hampshire PO12 3UL
Tel. +44/0 2392-520775 - Fax +44/0 2392-502559
e-mail: mcheckley@imshome.com

TECHNICAL SUPPORT

Tel. +00 (1) 860 295-6102 - Fax +00 (1) 860 295-6107
e-mail: etech@imshome.com

Intelligent Motion Systems, Inc.

370 North Main Street, P.O. Box 457
Marlborough, CT 06447 - U.S.A.
Tel. +00 (1) 860 295-6102 - Fax +00 (1) 860 295-6107
e-mail: info@imshome.com
http://www.imshome.com